

# electronics

radio, communication, industrial applications of electron tubes... engineering and manufacture

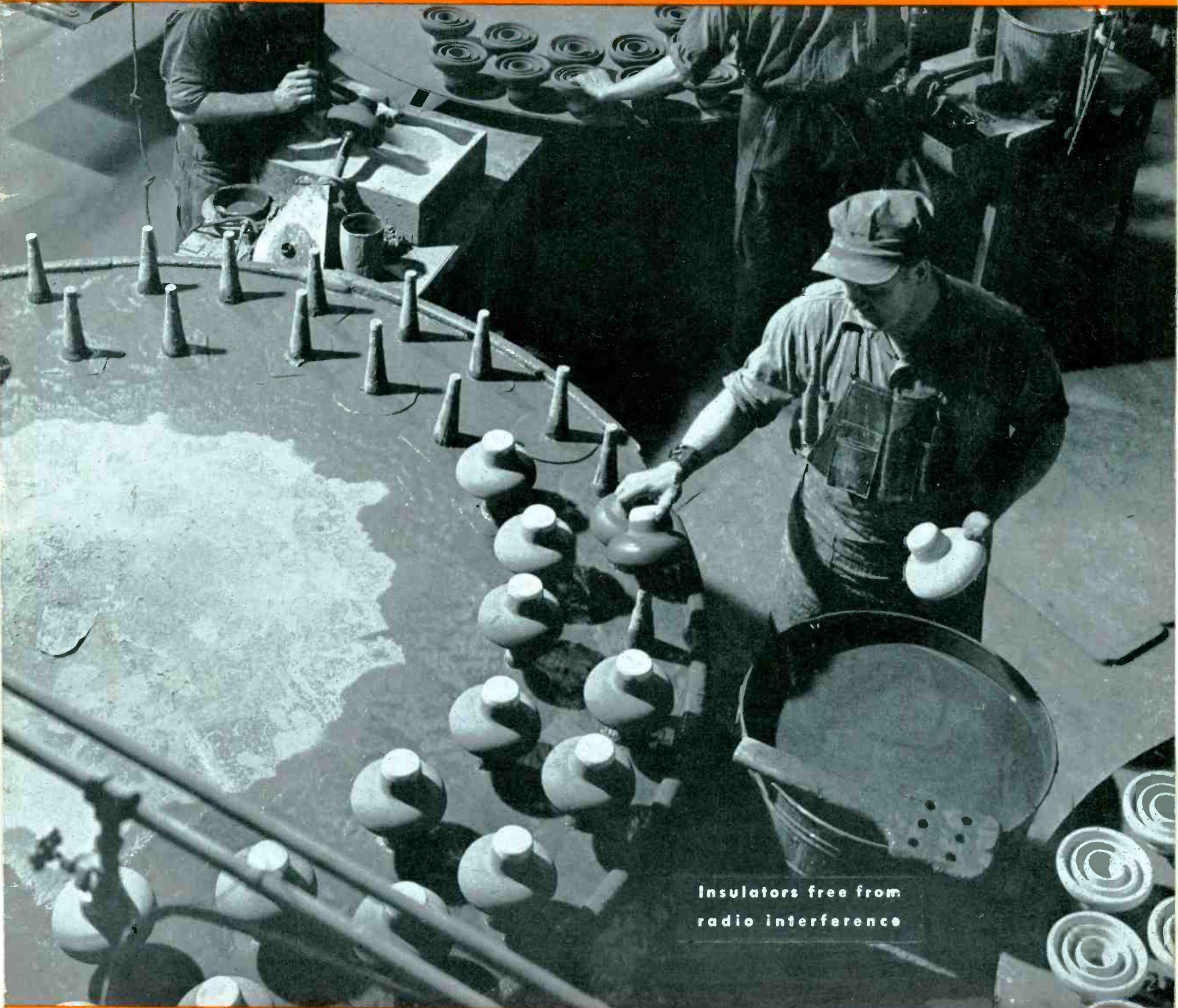

Insulators free from  
radio interference

McGRAW-HILL  
PUBLISHING COMPANY, INC.

SEPTEMBER  
1938

Price 50 Cents



**SOLAR**

GIVES

YOU

*more*

FOR YOUR MONEY



*Condensers* are much alike mechanically... but behind SOLAR Capacitors there is something more... the broad and deep experience of our laboratory and plant personnel. This powerful hidden ingredient makes the marked difference in PERFORMANCE which benefits the Radio and Electrical industries. Standardize on SOLAR... QUALITY ABOVE ALL

**SOLAR MFG. CORP., 599-601 BROADWAY, NEW YORK, N. Y.**

*Catalogs upon request*

# Combination Tones in Non-Linear Systems

By FRANK MASSA

RCA Mfg. Co.  
Camden, N. J.

THE purpose of this paper is to throw some light on an objectionable condition that occurs in a non-linear audio frequency system when two or more tones are being simultaneously reproduced: namely, the generation of combination tones consisting of sums and differences of small multiples of the original frequencies. Although it is generally known that such combination tones are generated, it may be surprising to learn that the magnitude of some of these tones may greatly exceed that of the simple harmonics. This being the case, it follows, of course, that more careful quantitative consideration will have to be given to combination tones if a high fidelity system is to simultaneously reproduce more than a single frequency.

## Generation of Combination Tones

Assume that an amplifier has a non-linear characteristic between input and output such that some second, third, fourth, and fifth harmonics appear in the output when a single frequency is being reproduced. For such a system, if two frequencies,  $f_1$  and  $f_2$ , are simultaneously applied to the input, it can be shown that a number of frequencies may appear in the output as indicated in Fig. 1. The increasing complexity of the combination frequencies with higher orders of non-linearity can be easily noted. For example, if only second and third harmonics were generated in the amplifier, with a single impressed frequency, the last two rows of combination tones would be absent when the two frequencies are applied. A quantitative expression for the magnitudes of the various combination frequencies shown in Fig. 1 is derived at the end of this article.

The generation of combination tones must be familiar to everyone. So-called "beat notes" which are observed when two frequencies are heard simultaneously are simply the differences of the two frequencies which are generated by the non-linear mechanism of the ear. The surprising fact, perhaps, is that the magnitudes of the simple combination tones may be much greater than those of the simple harmonics. Experimental confirmation of this statement was obtained by a simple test conducted on a conventional amplifier using the arrangement shown in Fig. 2.

First, the harmonic content present in the amplifier output was determined with a single frequency impressed on the input, and the results are shown by the curves in Fig. 3. These curves show the components as well as the total harmonic present at various output levels of the amplifier. Two frequencies of equal magnitude were next impressed on the

means that they should be multiplied by about 0.7 if the total r.m.s. output is assumed 100%.

At an output of 31 volts, where the second harmonic was 4% and the total harmonic 7½% (single frequency reproduction), the measured first order sum and difference tones were 14 and 15% respectively and the second order tones are shown at 10%

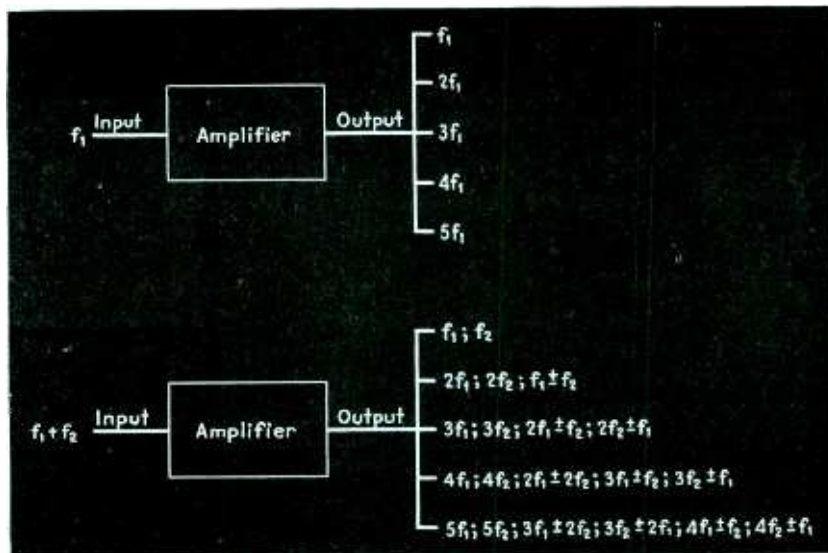

Fig. 1—Output frequencies of non-linear circuit with single and double sine wave input voltages

input and the gain adjusted to an output of 23 volts (r.m.s.) at which setting the total harmonic present for single frequency reproduction is shown as less than 2%. The measured sum and difference frequencies for this condition shows a value of 7½%. This percentage is in reference to an assigned value of 100% for the magnitude of either fundamental in the output. The second harmonic of either fundamental when they are both present simultaneously is shown as about 3%. It must be remembered that these values are relative to either fundamental, which

magnitude. Thus it is quite evident that combination tones of greater magnitude than simple harmonics may be generated in non-linear systems, even when as little as 2% total harmonic is generated by a single sine wave signal.

A few summarizing conclusions are listed below.

(a) Combination Tones More Disturbing Than Simple Harmonics

It has been shown that when two frequencies are simultaneously applied to a non-linear system, a series of combination frequencies are generated, of which the small order sum



By **E. L. DEETER**  
*Research Engineer,  
 Orchard Paper Company, St. Louis, Mo.*

microammeter and calibrated light valve are also located. Window traps for holding the samples to be tested are conveniently placed on the main body, as is also the filter slide. On the panel, covered openings are provided for the liquid color slides. These slides are of unusual construction in that they may be either hung on a nail or placed flat while containing fluids. The cohesion due to the small distance between the glass slides holds the liquid intact unless the container is completely inverted. The slides are cut from magnesium alloy and have glass covered slides that are easily replaced.

A description of the operations entailed in making a routine color test or match should be of help in explaining the functions of the light valve and shadow vane in the lamp house.

With all switches in the "off" position the main power switch is snapped on and the machine given several minutes to condition. The balancing circuit knob is now turned into the "on" position and the meter needle centered on mid-scale. A reflector is placed in the back window trap. One of the color filters is placed in the slide and the standard color is placed in the front window trap. The light source is next snapped on and with the calibrated light valve set at zero mid-scale the shadow vane in the lamp house is adjusted to bring the meter needle back to zero. The standard is now replaced with the sample to be matched against it. If the meter needle deviates from zero it indicates a mis-match, plus or minus. Again the meter needle is brought to zero by an adjustment of the calibrated light valve or iris diaphragm. When this condition obtains the reading on the light valve scale is indicative of the percentage difference in the tonal range of the sample and standard as far as that particular band of the spectrum is concerned. The other necessary filters are now placed consecutively and the above operations repeated. Red, blue and green Wratten filters are used.

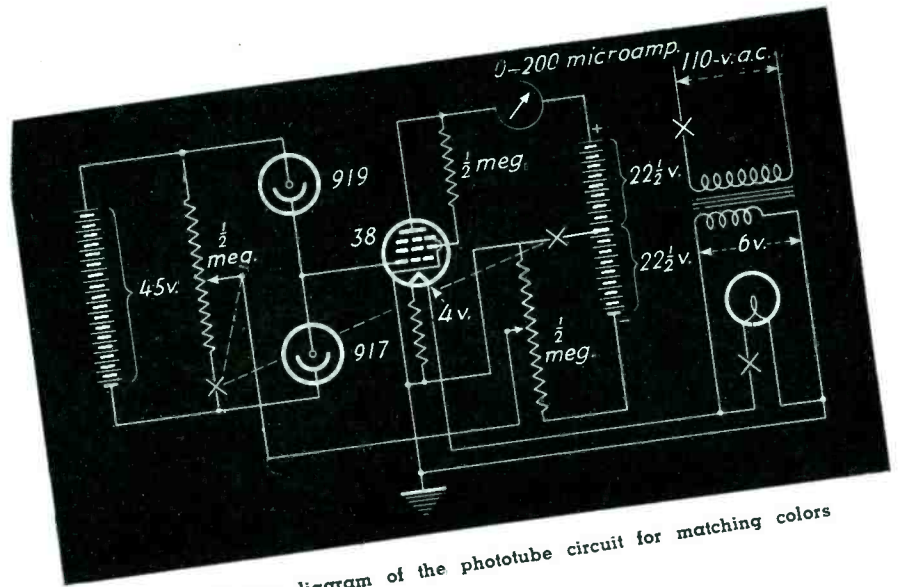

Fig. 1—Wiring diagram of the phototube circuit for matching colors

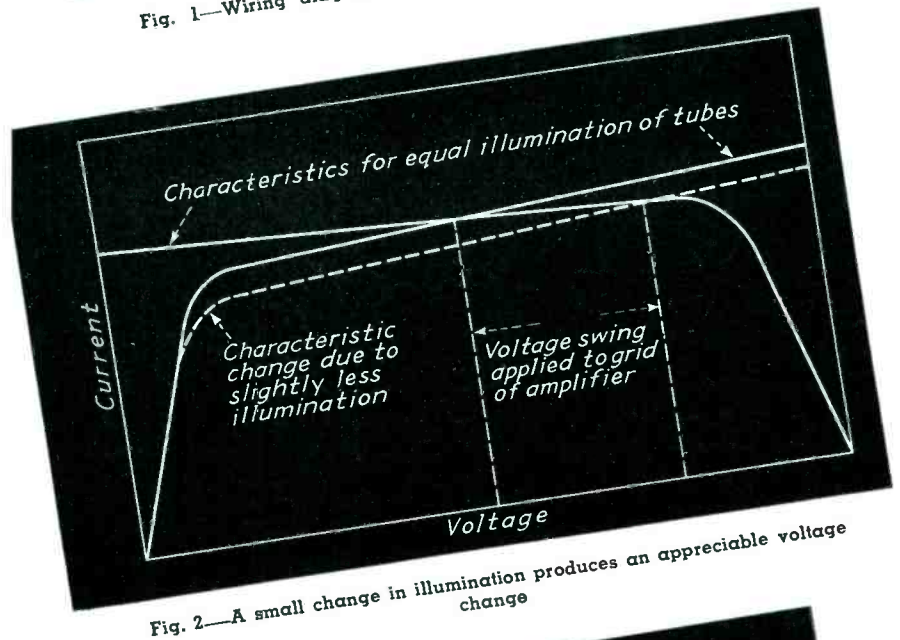

Fig. 2—A small change in illumination produces an appreciable voltage change

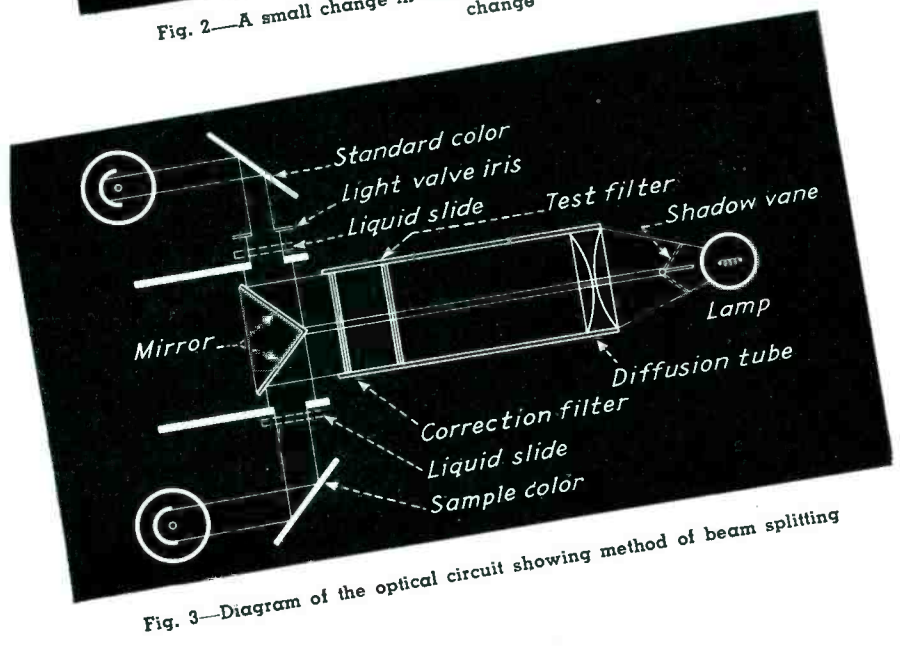

Fig. 3—Diagram of the optical circuit showing method of beam splitting

# Color Matching in the Paper

**A**LTHOUGH there are numerous color matching instruments on the market, including comparators, colorimeters and true spectrophotometers, many industries often require apparatus of special construction and design to handle efficiently their own specific products. In the paper manufacturing of specialties for instance, it becomes imperative to be able to match printing inks on repeat orders.

The instrument described by this article was constructed to fulfill such demands, that is, to designate color matches with high precision of colors or dyed papers by reflection or transmission methods.

A sensitive bridge circuit employing two RCA phototubes of the vacuum type was used and is shown in Fig. 1. A voltage divider across the charging voltage of the phototubes balances the system. By adjusting the voltage divider, the meter needle may be made to rest at mid-scale zero with no light on the tubes. When balanced electrically such a circuit exhibits characteristics illustrated in Fig. 2. Because the tubes are in series and must pass the same current, a larger quantity of light imposed on one tube as compared to the other produces a very definite shift of the intersecting curves, decreasing or increasing the mean total bias on the amplifier, a 38 pentode tube operating at 4 volts on the heater to increase stability.

The phototubes, type 919 and 917 are especially sensitive in a balanced circuit of this nature. These phototubes have top-cap connections, the anode being brought out to the cap on the one tube, the cathode on the other tube. As indicated in the wiring circuit, the grid cap of the amplifier tube connects only to the top-caps of the two phototubes. Short top-cap connections to the three tubes, result in an extremely high resistance leakage path. Leakage may be further decreased by coating the three tubes with a non-hygroscopic wax. The windows of the phototubes should be free from wax.

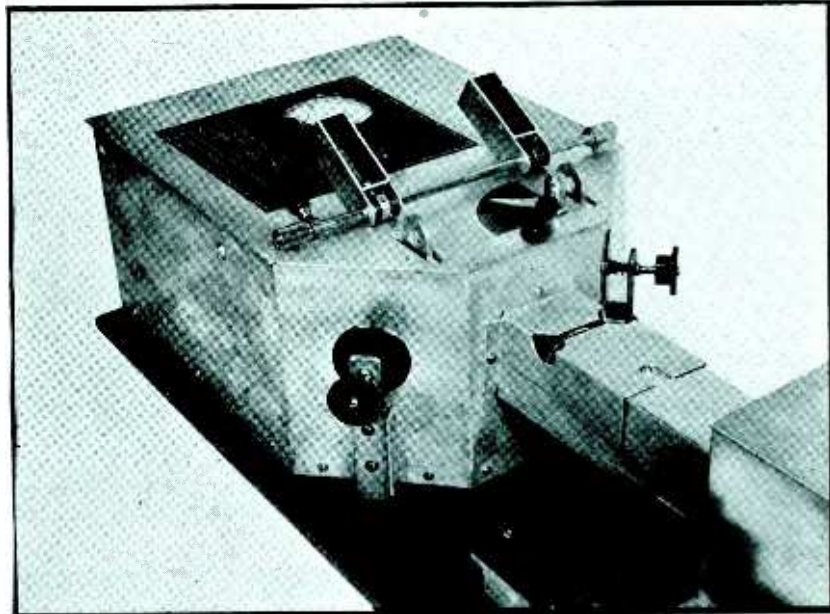

Fig. 5—Close-up view of housing containing electrical portion of the system, with liquid slides, light covers, and openings for sample and standard colors

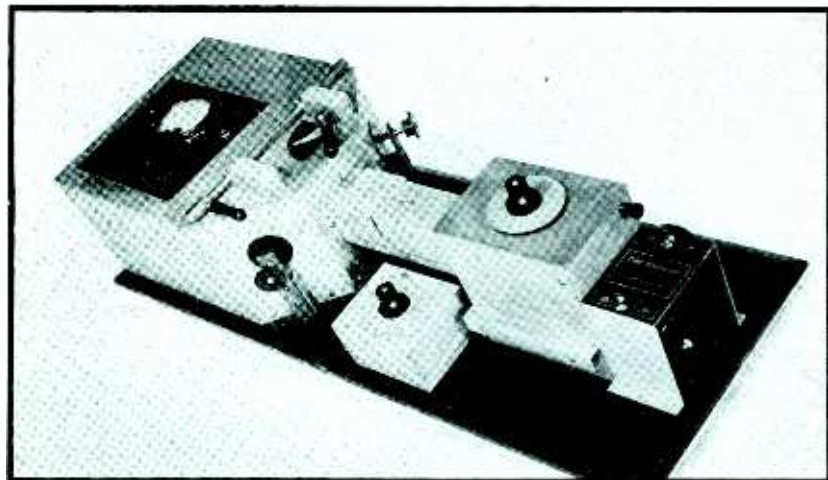

Fig. 4—General view of entire color matching device

A bias voltage divider on the pentode compensates for differences in phototube sensitivity by allowing shift of the grid-plate characteristics of the amplifier tube. Access to this adjustment is obtained at the end of the instrument by means of a screw driver. This adjustment requires attention only periodically.

The lamp house is located some dis-

tance from the main body to insure stability by reducing thermal variances in circuits. It contains the light source, a Mazda lamp of the concentrated filament type, operated at about 2800° K. The double condensing lens and light balancing shadow vane are also contained in this compartment.

Operating controls are placed on the main body panel where the 4 inch



equal to  $E$ , so that the voltmeter will show no deflection.

If a voltage ( $V_i$ ) from an external source is now made to appear across  $R_i$ , a voltage change ( $V_o$ ) will appear across  $R_o$ , and will be registered by the voltmeter. It will also appear, in series—opposition with  $V_i$ , on the amplifier input terminals, very nearly balancing out the effect of  $V_i$  on the input grid. It can be shown that, in equation form,

$$V_o = V_i \left( 1 - \frac{1}{1+G} \right),$$

where  $G$  is as previously defined. If this gain is made quite large, voltage change across  $R_o$  (indicated by the meter) will be but negligently different from that impressed across  $R_i$ . Thus, the system becomes a voltmeter with an input resistance solely determined by  $R_i$ , and the large available current gain in the amplifier permits the use of a sturdy indicating meter while also obtaining high sensitivity for large values of  $R_i$ . The accuracy of such an instrument is determined primarily by the tolerances of  $R_i$  and the indicating meter—since appreciable variations in amplifier gain, if it is normally large, have only a second-order effect.

By using a wide range of input resistances ( $R_i$ ), the instrument becomes an ammeter with corresponding wide ranges. By using high resistance dividers in place of  $R_i$ , it becomes a multi-range voltmeter with low current drain. Connecting a standard potential, in series with an unknown resistance, across  $R_i$  converts the instrument into a direct-reading ohmmeter (with properly calibrated scale) capable of very high resistance measurements with low applied voltage.

The meter here described provides these three functions of current, voltage and resistance measurement in 22 different ranges, available by means of a selector switch, a sensitivity button and three pairs of binding posts. Reference to the schematic diagram of Fig. 1 will show that it is identical in principle to the system just described, except for the addition of various controls. The range selector switch is omitted from this drawing for simplification, and the three types of input circuits used are indicated.  $R_i$  corresponds to  $R_i$  of Fig. 2,  $R_o$  to  $R_o$ , and the combination of  $R_{10}$  and  $M_1$  to  $V.M.$   $S_1$  is a sensitivity button which changes the range of  $M_1$  from 0.5 to 0.1 volt full-scale.  $B_1$  corresponds to  $E$ , and  $R_1$  is the adjustment for setting the equilibrium feed-back voltage across  $R_o$  equal to the potential of  $E_1$ , (actually varying the "lock-in" potential on the grid of the tube 1).  $R_2$  is the megohm scale zero adjustment which, according to a simple specified procedure, furnishes a standard potential of 0.5 volt for resistance measurements.

The d-c amplifier is battery coupled and operates conventionally, except that it is designed for low battery voltage and current drain—providing compactness and long battery life. The minimum voltage gain from input grid to  $R_o$  is approximately 1000. According to the feed-back equation previously

cited, this gives an inherent discrepancy of 0.1% between input and indicated voltages, and thus a rather large percentage change in gain does not affect the practical accuracy of the instrument.

If a potential of 0.5005 volt is made to appear across  $R_i$ , a voltage change of 0.5000 will occur across  $R_o$ , changing the bias on tube 1 by this amount, and be registered as full scale on the meter  $M_1$ . The grid-filament voltage on tube 1 thus changes by only 0.0005 volt. This small operating range of grid voltage on tube 1 reduces the error due to changing grid current in  $R_i$  to a negligible minimum. Actually, only change of grid current with changing voltage across  $R_i$  will produce error in current measurement,—this change being reduced by the small grid voltage range. However, by operating all tube filaments between 1.5 and 1.25 volts, the "static" value of grid current (largely ionic) is reduced to less than  $10^{-10}$  amperes, and the value of the input resistor  $R_i$  may thus be switched from low values to 5.0 megohms (highest used) without appreciable change in balance or zero setting. Moreover, the value of the dynamic input resistance ( $-dE_g/dI_g$ ) around the operating point is thus raised to the order of 10,000 megohms—

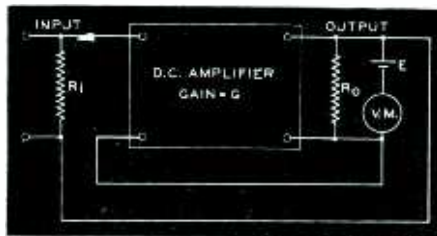

Fig. 2—Basic circuit of the meter

a negligible shunting effect on the highest input resistor used.

The negative feed-back circuit provides unusual stability of balance or zero setting. For instance, a small change in the mutual characteristic of tube 1, which ordinarily would throw the indicating meter off scale, will result in a similar small change in the equilibrium feed-back voltage, with a corresponding small change in meter reading. Shifts in the characteristic of the first tube, due to changes in element spacing, emission or supply voltages, are the most likely sources of such drift in zero setting. These are minimized by cushion mounting and small dissipation in tube 1, and very light drain on the supply batteries. After a short warm-up period, and with normal handling and vibration conditions, the actual zero drift is less than 2 scale divisions per hour and 0.2 scale division per minute.

The grid circuit of tube 1 contains a filter ( $R_i C_i$ ) which greatly attenuates a-c components from the circuit under test (without appreciably decreasing the normal speed of the indicating meter), and protects tube 1 from very large overloads of d-c voltage. Interaction between the meter amplifier and any device under test is also thus prevented.  $C_i$  and  $R_o$  prevent the amplifier from oscillating at very high frequencies, where the over-all phase angle reverses to give positive feed-back. The general problem of stability in feed-back amplifiers is beyond the scope of this paper; however, an excellent analysis of this subject has been made by H. Nyquist—*Bell System Technical Journal*, Vol. XI, p. 126.

The plate current of tube 3, for no input to the instrument, is adjusted to balance the potential of  $B_1$  by the drop in  $R_o$ . However, driving this tube to cut-off or saturation (by over voltage on the input or other means) cannot cause a damaging overload voltage to appear across the meter  $M_1$ , so long as the sensitivity button  $S_1$  is not held down—thus practically eliminating the possibility of meter burn-out. Combined with the protective elements in the input grid circuit, this makes the instrument practically fool-proof.

Tremendous overloads can at most burn out one of the resistors in the input bank and will in no way damage the output meter. On the most sensitive ranges,  $10 \mu\text{a}$  or less full scale, the instrument may be connected across a 110 volt power line, a-c or d-c, without damage of any sort.

A polarity reversal switch,  $S_2$ , is provided so that unbalance in either direction in the input circuit can always be indicated as a positive deflection on  $M_1$ . This is particularly useful in current or voltage measurements, in that the "high" terminal of the instrument may always be connected to the measuring point most remote from ground, irrespective of its polarity.  $S_2$  is a switch by which the voltage of the filament battery may be conveniently checked on  $M_1$ .

The tolerances on the various input resistors and the meter are such that an overall accuracy of  $\pm 2\%$  of full-scale reading is obtained for ambient temperatures between 50 deg. and 100 deg. F, and normal values of relative humidity. Very special precautions have been taken, in the

(Continued on page 52)

# A Feedback D-C Meter

A portable, electronic, multi-purpose, d-c instrument having a resistance of 50 megohms per volt at greatest sensitivity, full-scale current sensitivity of  $0.02 \mu\text{a}$ , capable of measuring resistances of the order of 200,000 megohms

By J. M. BRUMBAUGH and  
A. W. VANCE

RCA Manufacturing Co., Inc.,  
Camden, N. J.

ORIGINALLY developed in the Electronic Research Laboratory for weak-current measurements on Iconoscopes, electron multipliers and associated devices, the meter to be described fulfills a long-standing need for a sensitive and accurate d-c measuring instrument which would also be portable, rugged, stable in adjustment, and not easily burned out or thrown off calibration when measuring small fractions of a micro-ampere. In satisfying these requirements, this meter, on its most sensitive current range, gives 1 ma deflection for  $0.00022 \mu\text{a}$  ( $0.02 \mu\text{a}$  full-scale). Provision is also made for multi-range voltage measurements at unusually low current drain, and for direct resistance measurements from .1 to 1000 megohms with less than 0.5 volts applied potential. (Measurements up to 200,000 megohms may be made by use of a 90 volt external battery.)

For certain types of d-c measurements, the use of the absolute null method, with a very sensitive indicating device, is desirable. For precision bridge measurements, or similar balance-indicator requirements, no essential improvements have been made over the suspension galvanometer having high current sensitivity and low internal resistance, with manual or automatic balancing. In many cases, however, where very weak currents are to be measured, as in electron tube investigations, a potential drop of a fraction of a volt in the measuring device is not objectionable, particularly if the value of this drop is indicated directly on the device. Thus it would seem that unusual current sensitivities might be attained by passing the current through a relatively high resistance,

providing that a stable, high gain amplifier is available to drive an indicating instrument from extremely small input power.

Special requirements for investigations in the RCA Electronics Research Department have resulted in the development of a d-c amplifier which is ideally applicable to this problem. In this design the effects of supply voltage and tube characteristic variations on calibration accuracy have been reduced to small second-order effects, and the tendency toward drifting has likewise been reduced to negligible proportions. This is accomplished by the use of a negative feed-back circuit, wherein the ability of an amplifier to give large amplification is utilized, not to produce large voltage gain but to provide substantially unity voltage gain of great constancy and accuracy, and give large power gain for driving a sturdy indicating meter.

The use of this principle has resulted in a rugged, self-contained and portable instrument having a maximum current sensitivity which is roughly equal to that of the most delicate suspension-reflection galvanometers—or about  $.00022 \mu\text{a}$  with

$5.0 \mu\text{w}$  delivered to the indicating meter for  $0.002 \mu\text{w}$  input to the instrument ( $0.1$  volt across 5.0 megohms).

## Ultra-sensitive D-C Meter

As now made the ultra-sensitive d-c meter consists essentially of a group of input circuits (selectable through a range switch), a d-c negative feed-back amplifier, and an indicating meter. The principle of operation may be most easily understood by referring to Fig. 2, which shows a d-c amplifier with its output connected in series with its input. In the actual instrument three stages are used to provide adequate gain and the proper phase relation for negative feed-back. When such an amplifier is connected in this manner, it will "lock-in" at what may be called its equilibrium condition—which represents a certain voltage on each plate and grid (with respect to cathode) and a certain feed-back voltage developed across  $R_o$  and returned to the input (i.e., the input tube receives its bias from the plate current of the output tube). If no potential is applied to  $R_i$ , the system will tend to maintain these voltage values with a constancy proportional to the gain  $G$  (amplifier voltage gain, without feed-back connection). Any tendency toward oscillation at very high frequency (where the phase angle reverses) is prevented by proper filtering. It may be assumed further that the amplifier is internally adjusted so that the equilibrium feed-back voltage is just

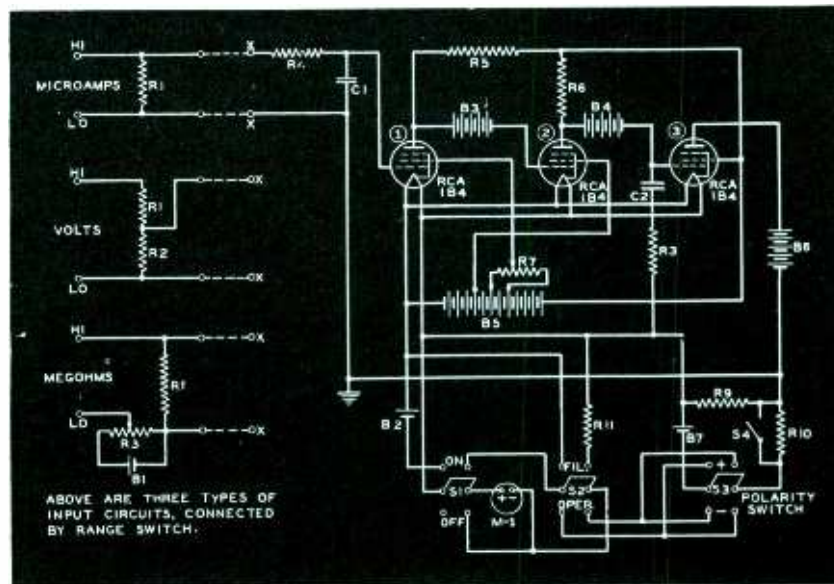

Fig. 1—Fundamental diagram of the RCA Ultra-sensitive D-C Meter



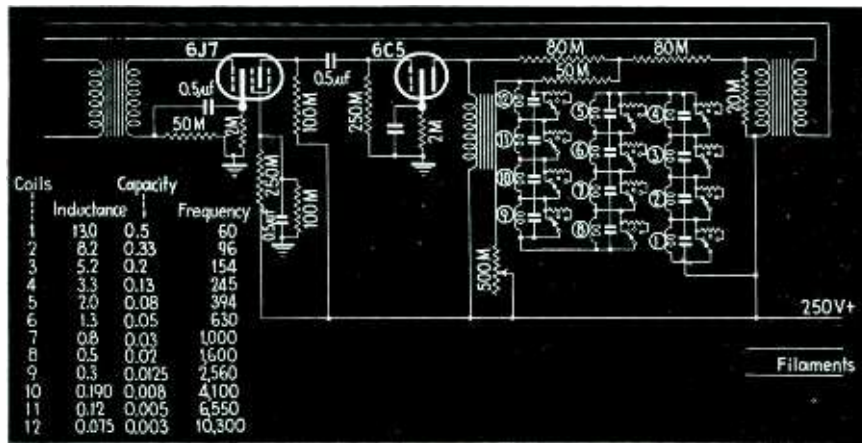

Fig. 2—Complete circuit diagram of pre-amplifier with values of reactance units

# Pre-Amplifier

by C. F. SHEAFFER  
KTUL, Tulsa, Okla.

$$f_1, f_2 = \frac{\sqrt{L^2(K-1) + KLCR_sR_0} \pm \sqrt{L^2(K-1)LCR_s(KR_0 + 4R_s)}}{2\pi LCR_s} \dots (4)$$

Equation (4) gives the proper value of the mid-frequencies on either side of the anti-resonant frequency of the tuned circuit being considered. The ratio of the two answers is therefore equal to the frequency spacing constant  $p$ , which will be explained later.

There remains now only to discover the value of the factor  $K$ , and determine whether or not it remains constant when other conditions of the equation are varied. This has been done empirically by summing up the impedances for the best fit. It was found that  $K = 1.7$  was the most satisfactory value, and that while  $K$  varied somewhat with conditions, this value rendered the equation sufficiently accurate for design purposes. Lower values of  $K$  will also give a flat characteristic, but it has been found that the lower the value of  $K$  used, the more markedly does the total impedance at any given frequency depend on the associated circuits. Higher values of  $K$  require correspondingly higher values of  $R_s$  with a given frequency spacing.

The anti-resonant circuit is an energy storing device. The energy absorbed from the supply source must be dissipated in the resistance  $R_s$  after the supply is interrupted. This gives rise to an effect which is quite

similar to the building up and dying out of sound energy in an acoustically live room. An equation which gives the time it takes oscillations set up in an anti-resonant circuit to die down to 1/1000 their original amplitude is

$$T = \frac{6.9 R_s}{\pi F \sqrt{\frac{L}{C}}}$$

This equation is synonymous with reverberation time, and shows that the above mentioned effect will be small in comparison to normal reverberation provided the ratio  $R_s/\sqrt{L/C}$  is not greater than 4.

## Design Procedure

The following conditions were selected as suitable for the described instrument:

- Surge impedance of each anti-resonant circuit = 5000 ohms =  $\sqrt{L/C}$
- Frequency range = 60 to 10000 cycles
- Number of circuits to cover the range = 12
- Individual coil  $Q = 10$
- Overall amplifier gain for flat characteristic = 30 db (approx.)

Each succeeding tuned circuit will be tuned to a frequency which is a given percentage of the one preceding it, so that if  $p$  is the multiplying factor and the initial frequency is 60 cycles the tuned circuit frequencies will be 60,  $60p$ ,  $60p^2$ ,  $60p^3$ , . . .  $60p^{(n-1)}$ .  $p$  is therefore equal to the  $(n-1)$ th root of  $10000/60$ , or approximately 1.6. The 12 frequencies are therefore 60, 96, 154, 245, 394, 630, 1000, 2560, 4100, 6550, 10300.

The resistance shunt value may be computed from equation (3), and will be 10,300 ohms, or approximately 10000 ohms. The inductance and capacity values are given in Fig. 2. The coils may be hand wound on paper spools and calibrated by varying the number of laminations in the core, but the building of high-Q iron core coils is quite an art, and a lot of worry and work will be saved if this job is turned over to one of the transformer companies.

The schematic diagram shows the arrangement of the tuned circuits and their associated switches which are SPDT with an off position in the center. They are connected so as to allow the application or removal of the resistance shunt, or shorting, as desired. The amplifier design is sufficiently indicated in the diagram and will not be discussed. The anti-resonant bank was placed in the output circuit so that the level would be high enough to override any hum picked up by the coils.

## Application

A great many variations in the amplitude-frequency characteristic are possible. With the shunts removed sharp narrow peaks may be obtained at any of the tuned circuit frequencies. These are especially helpful in mimicking various telephone transmitter and loud speaker characteristics. A few acoustic effects similar to speaking into a cellar could be imitated by removing the resistance shunt from various low frequency coils.

The frequency discrimination for low, high, or band pass operation is very nearly as good as that afforded by the usual filter type equipment.

All coils may be shorted out and the series resistance opened up for flat characteristic operation. It may therefore be used as a regular pre-amplifier. The pre-amplifier set-up is especially satisfactory as it does away with insertion loss difficulties and affords a suitable means of introduction for low level mixer equipment.



Fig. 1—Impedance Characteristics of several loaded anti-resonant circuits and their series sum

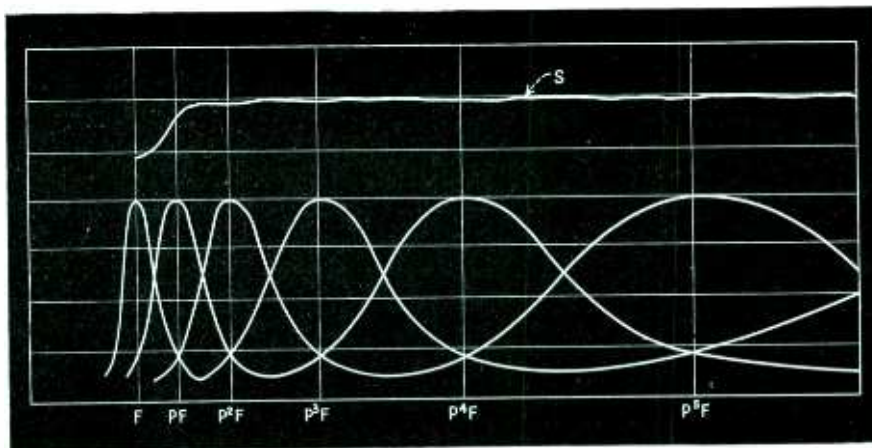

**S**OUND effects requiring various frequency response characteristics are most satisfactorily created electrically so that they may be controlled by the engineer. This has usually been accomplished by means of a low and high pass filter combination arranged so that a frequency band of any desired width might be transmitted. Many of the effects obtainable from such a system may be more accurately simulated by transmitting two or more bands, however, and a more flexible means of controlling the amplitude-frequency characteristic is therefore desirable. It was also deemed likely that new uses could be discovered with an instrument offering greater flexibility. The device described in this paper has been designed to give a wide variety of amplitude-frequency characteristics and has proven, in many respects, to be superior to the filter method.

The instrument consists of a pre-amplifier into which is incorporated a series bank of anti-resonant circuits whose anti-resonant frequencies are systematically scattered throughout the audio spectrum. The unit is designed in such a manner that with all coil-condenser combinations in the circuit, the complete audio band is transmitted without frequency distortion. By shorting out various coil-condenser units, therefore, the transmitted band may be narrowed or cut into at any desired spot in the spectrum.

#### Theoretical Basis

In considering the principles involved in the design of the anti-resonant circuits, let us initially examine two circuits in series whose anti-resonant frequencies are, let us say, 1000 and 2000 cycles respectively. At the mid-frequency, which is approximately 1450 cycles, circuit 1 will have an impedance of  $R - jX$  ohms and circuit 2 will have an impedance of  $R' + jX'$  ohms. The total impedance at the mid-frequency will therefore be  $R + R' + j(X' - X)$  ohms. If the

same value of  $L/C$  is used in designing both circuits,  $X$  will equal  $X'$  and the impedance at the mid-frequency will be a pure resistance equal to  $R + R'$ . Now if some means of adjusting  $R + R'$  with respect to the impedance at 1000 or 2000 cycles is devised so that the total impedance at the mid-frequency was equal to that at either of the anti-resonant frequencies. The impedance of the combination would then remain approximately flat from 1000 to 2000 cycles. To these circuits we might now add others designed to have the same  $L/C$  ratio with anti-resonant frequencies at 125, 250, 500, 4000, and 8000 cycles; and with all these in series the impedance could then be made flat throughout the included band. It will be noticed that each frequency is a constant percentage of the one below it. This simplifies design procedure and is in keeping with the acoustical law which states that we perceive percentage frequency changes.

#### Mathematical Analysis

The magnitude of the resistive components of any two adjacent tuned circuits at their mid-frequency may be adjusted by shunting each with a suitably sized resistor. It is therefore necessary to set up an equation which will yield the size of the resistance shunt in terms of the other circuit constants.

The impedance of any coil-condenser combination at its anti-reso-

nant frequency with a resistance shunt is

$$Z_{ars} = \frac{\left(\frac{L}{CR_0}\right)(R_s)}{\frac{L}{CR_0} + R_s} = \frac{L R_s}{L + R_s R_0 C} \quad (1)$$

An approximate equation for the impedance at any frequency neglecting  $R_0$  (very nearly correct provided the coil  $Q$  is reasonably high and the frequency is removed from anti-resonance) may be rationalized to obtain the resistive component:

$$R_1 = \frac{R_s L^2}{R_s^2 C^2 \left(\omega L - \frac{1}{\omega C}\right)^2 + L^2} \quad \dots (2)$$

If the proper relations exist between the total impedance at the anti-resonant frequencies and the total impedance at the mid-frequencies, then the impedance characteristic will be approximately flat. It is assumed, therefore, that a similar relation exists between the impedance of an individual anti-resonant circuit at its mid- and anti-resonant frequencies. We proceed to set the right-hand side of eq. (1) equal to  $K \times$  the right hand side of eq. (2), where  $K$  is a multiplying factor set to make the equation true.

The equation is quadratic in  $R_s$  and  $\omega$ , and may be solved to obtain the equations below:

$$R_s = \frac{L}{C} \times \frac{KR_0 + \sqrt{K^2 R_0^2 + 4(K-1)\left(\omega L - \frac{1}{\omega C}\right)^2}}{2\left(\omega L - \frac{1}{\omega C}\right)^2} \quad \dots (3)$$

## A Sound Illusion

Phototubes count beer cases and kegs in New York breweries under conditions destructive to mechanical counters

# Electronics Helps Make Beer

*(Reading from top to bottom)*

Outdoor case counter. Empty beer cases received at platform on floor below, travel upward on enclosed conveyor into storage room. Light source and phototube relay are mounted on the conveyor enclosure, and connected to a separate housing on the receiving platform below, where control switch, fuses, and magnetic counter are located

Two conveyors, two photo tube counters. Photorelay housings on wall behind conveyors. Counters are the non-reset type, completely enclosed, and directly actuated by the relay tube plate current. The cases separate at their outer edges as they round the curves; this enables an oblique light beam to count them. Normally they move fairly slowly, but occasionally they come down the long conveyor at such speed that it is impossible to follow them by eye. Mechanical counters at this point were pounded to pieces. The light beam system seems to stand up quite well

Case counter using two light beams. Here, the cases sometimes back up a few inches. As long as a case does not move back more than the distance between the light beams, any number of multiple interruptions result in only one count

Waterproof double-beam unit counting two sizes of kegs going down a runway. Large kegs interrupt both beams; small kegs only the lower one. The respective counts are registered on a unit shown by photograph below

Counters in an office some fifty feet away. The control switch, fuse panel, pilot light, and counters are located here. This system was designed and installed by the Luxtrol Company, New York City

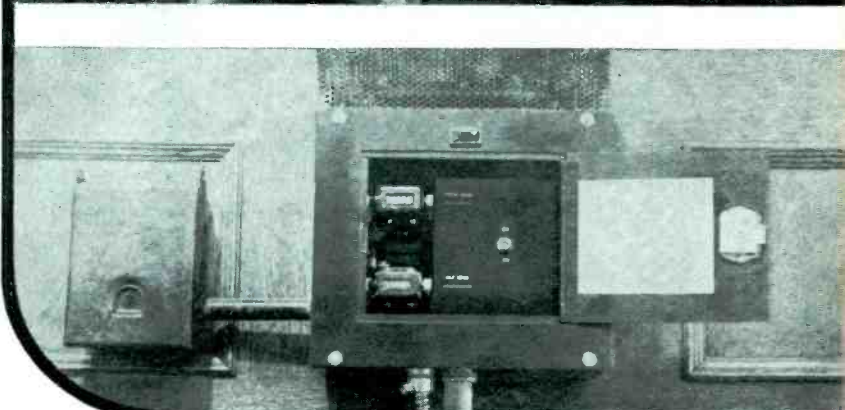
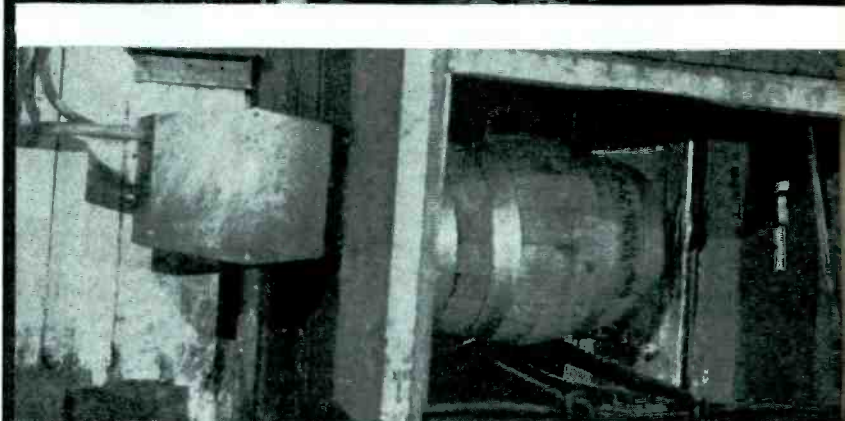
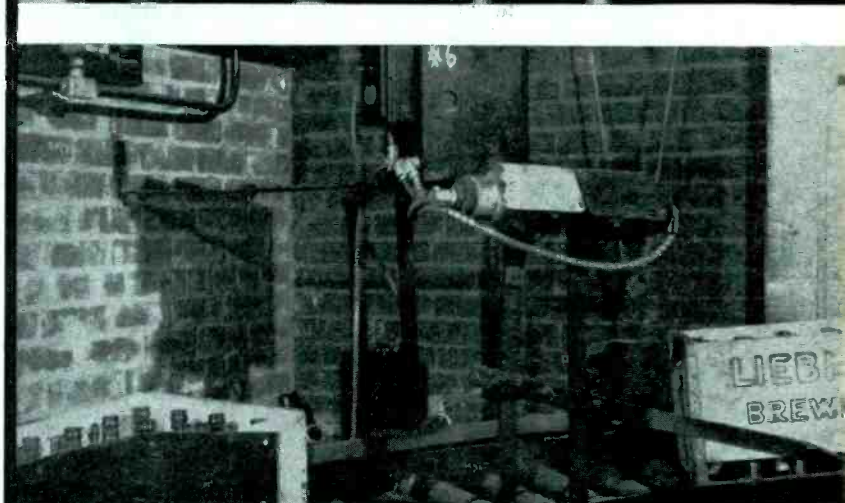
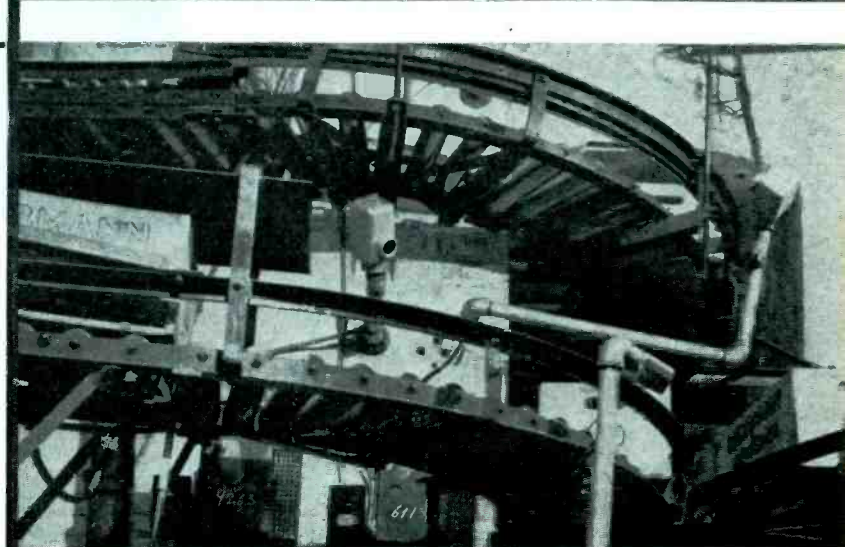



One of the reasons industrial electronics moves forward so slowly is the fact that there are not enough engineers who know electronic engineering to put the profession on an organized basis. In the present stage of the business most of the "consulting" consists of tinkering by mechanical, electrical and radio engineers. Five thousand competent engineers who know their stuff, and a realization by manufacturing concerns that the information they want must be paid for, would be a good start in a real electronics industry.

*How much is electronic equipment worth?*

This brings up the problem of compensation. Engineers in large manufacturing concerns who make electron tubes, amplifiers, photo cells, etc., are being pestered constantly by engineers in various plants who have problems which they think can be solved by some mysterious hocus pocus called electronics. First thought is to call on these companies to solve their problems. "Please send blueprints and specifications."

The large companies cannot offend these boys because they buy lots of non-electronic material from the big companies every day. All the men in the control division can do is to try to help the fellow out and do it diplomatically. But they are not fond of the job and feel they are being imposed upon. They send me hundreds of such problems every year and once in a while one turns into a job. Sometimes the same problem comes in from more than one company indicating that the originator of the problem has called on the engineering and development divisions of several of the largest organizations of that kind in the world with the expectation that these large companies should turn their whole staff loose on this one job. I have never gotten enough business out of the inquiries received from the big companies to pay for handling them although I have spent months in time working up proposals for machines. The big companies feel that they should do the engineering but that I should tell them how. Like every one else I have my weak moments and do tell them. Fully 20% of these problems that I get have an electronic solution and half of the 20% would be profitable to the user.

Unless a fellow has the backing of some financial angel he will miss a

good many meals before he gets much business as a consultant in industrial electronics. In order to get business you must be prepared to deliver a complete apparatus to do the trick. This puts the engineer in the manufacturing business. Even then you are sunk unless you get an order or a contract setting forth exactly what the machine is to do and then get a 25% cash advance. Sometimes you can sell engineering services. Recently I did a job on an engineering basis which saved the company \$11,000, over the cost of what they would have had to pay me if I built the machines on contract for them.

*Having got a job, how much should we charge?*

The ordinary manufacturer of a gadget, built for resale, figures that the final retail price must be from three to five times the actual production cost, based on direct labor and material. Often, costly engineering and experimental work are required to develop a machine to do a special job. It should not be exorbitant to charge ten times the cost of the actual labor and material that goes into the machine, but it is difficult to sell the purchaser on this idea. In one instance, I delivered a machine that saved the manufacturer \$100.00 every 24-hour day it operated and it replaced much needed help that was made available for another department. The price of the machine was \$3,000.00 and upon receipt of the order I was requested to deliver it at the earliest possible moment. The machine was designed from the ground up and the actual cost was \$600.00 in labor and material and delivered in six days. When it was delivered and put into operation everyone in the concern was highly pleased with its operation but when the day for payment came, the manager of the company said, "Surely you don't expect us to pay \$3000.00 for a machine that took you only a week to build at a cost not exceeding \$500.00." I promptly told him that I was taking that machine away that afternoon, that the deal was off, and that the machine was sold on what it did, not on what it cost me to build. (They had already spent several thousand dollar in trying to develop their own machine of this kind.) The superintendent was a listener-in and he came over and gave me a nudge, "Don't pay any attention to this fel-

low. We want another machine."

*Should we give free advice?*

I have built much automatic gauging equipment, mostly for measuring the diameters and lengths of straight rolls for roller bearings. The operation is simple in the extreme. You simply have your gauging part break a grid circuit to a vacuum tube which in turn causes the plate circuit to operate a relay and devise some mechanism for getting the piece out from under the micrometer and into the correct box. You, of course, have to compensate for temperature if your machine is to measure within a few millionths of an inch, synchronize the operations and feed the machine, make it variable in speed, design the spindles so they won't wear or get dirty and solve a number of other minor mechanical problems. Furthermore, it must operate a week or more without attention.

I had built a number of these machines and had them in operation when I saw an ad in one of the trade magazines reading something like this—

"The Punky Sink Company manufactures its parts by the very latest known methods of inspection. There is no question but what we have every known method of measurement and we are constantly applying it to our product. Nevertheless our doors are wide open to anyone who can show us better methods and we welcome with open arms anyone who can show us how to improve our product by gauging and inspection methods."

As the Punky Sink people are one of the biggest in the business and turn out millions of precision parts that should be measured automatically within tolerances of .0002, I thought here was a chance for some real business. So I wrote them and in about a week received a reply signed by an engineer. Although the plant was 600 miles from Cleveland I caught the first train and went forth.

I waited in the reception room about two hours (the engineer knew I was coming) and got a call to come back after lunch. Then another two hour wait and I got in the office. I did not see the engineer, however, but his assistant who proceeded to spend about an hour telling me how good they were and that I should consider it a privilege to make a spe-

*(Continued on page 52)*

# A Consultant Talks About ELECTRONICS

By REX D. McDILL

ONE does not need to be a consultant in electronics very long before he discovers several things. In the first place, it is not one of the big-money businesses. Secondly, there is no other profession where the experimentally minded engineer can get more real enjoyment. Finally, one soon learns to classify prospects and clients in the following groups:

First, the fellow that wants you to come into his plant and design and build the apparatus to handle a particular job. Second, concerns that prefer to buy a machine or apparatus to do a particular thing. Third, the ones that employ you as a consultant and expect to pay you for it. Fourth, the engineers in various plants that expect you to tell them how to do it for the fun of doing it. This class is composed mostly of so-called research men who want to make a hit with the boss and from them the most inquiries are received. Fifth, the miscellaneous unprofitable inquiries, such as the letter cited below:

Gentlemen:

We have been informed that you manufacture a low-priced photocell that could be employed advantageously in a merchandise dispenser. The kind of cells we are mainly interested in are divided into two separate classes, namely, one that will detect one person from another by the slight difference in color, etc. After the dispensation of merchandise has been completed, there should be no repeat delivery to the same person for a considerable period, but another person who has not received any merchandise over a certain period can receive a full portion of it right after delivery has been completed to another person, without delay.

The second type of cell is one so

arranged requiring the lapse of 10 or 15 seconds before another delivery can be made.

Trusting to hear from you by return mail, etc.

In the last five years I have received many letters of this type, most of them from small concerns. Such letters prove that there are still a lot of people who think that they can nail a photocell on a barn door and have the light from the lantern open it up at milking time. But when a large manufacturer writes in and states that it would be worth a couple of hundred dollars to devise a fully automatic means for keeping flies out of beverage bottles, you are getting into the money class and business is picking up.

#### *What Is Electronics?*

Industrial electronics is really not a part of electrical engineering and much less a part of radio engineering. It is principally mechanical engineering and the electronic part is simply used where mechanical methods are not available. It is for that reason that radio engineers are not particularly fitted for industrial electronic work unless they can visualize a mechanical machine operated by electronic controls.

Many problems can be solved with standard equipment, that is, equipment already being manufactured. Inquiries on such problems should be referred to companies manufacturing the standard units. My experience shows that it is not practical to build in the laboratory everything that is used in an installation. Where standard units can be bought, these are



purchased direct from the maker.

There are a number of large organizations and a few moderate sized ones that could well afford to hire an industrial electronics engineer as a consultant to work directly with their engineering and manufacturing departments. Even though he does not turn out for them any piece of work that is highly profitable, he can usually steer them clear of costly but impractical developments in the electronics field.

Industrial electronics is 97 per cent mechanics and 3 per cent electronics. The 3 per cent is as essential as a hundred miles of track in the center of a transcontinental railroad. A thorough knowledge of the operation of telephone type relays and switches is probably as important to the industrial electronics engineer as a knowledge of what makes a vacuum tube act as a valve.





## EFFERVESCENCE

These objects are not bubbles, as you might think, but radio tube glass beads under inspection in diffused light

# ELECTRONICS

SEPTEMBER  
1938



KEITH HENNEY  
Editor

## Crosstalk

► **EVERYBODY CARES . . .** In the conviction that better relations between capital and labor, between employer and employee, between management and stockholder are necessary before any lasting good times may be had in this country, *Electronics* presents in its October issue a plan by which such better relations may be attained.

We believe that American business is everyman's business; that employees, stockholders, consumers have an interest in and a right to know about industry's problems, where its money comes from, where it goes. We believe that everyone cares when plants are idle because of misunderstanding, mismanagement, or because of the selfish aims of a few.

We believe that the game now being played by capital and labor is destructive of everything that is right and just and that if it is not terminated, soon, it will ultimately destroy the democratic principle in this country; that in this game the middle man—the consumer—must inevitably play a more active part than merely supplying the ante. Capital and labor must get together as they have in other democratic countries long ago. Management can aid in attaining this happy liaison if it will tell the truth about itself, if it makes certain that the public learns the facts of business life. Some of these facts pertaining to the industries based upon the electron tube are told in the coming October issue.

► **CRYPTIC . . .** One of *Electronics'* good friends who signs his post card from Denmark as "guess who" has the following to say on the state of television abroad: "television in London not as good as RCA. Poorer background transmission. Poorer low frequency transmission. Sets range from \$95 to \$225. None smaller than 9 inch which

is the trend. Trend now from 12 to 9 inch which is surprising. Economics is the reason. Tubes are shorter and tend to magnetic focus and deflection.

Television looks like the toy wife of radio rather than its master. 9000 sets in use; real British figure."

► **MS . . .** Stevens Institute of Technology, Hoboken, N. J., is offering for the first time an evening schedule of graduate courses leading to the degree Master of Science. Dr. Llewellyn of the Bell Laboratories will give a course in Vacuum Tube Electronics. Sessions begin the week of September 26. Prerequisite to enrollment is a degree in engineering or applied science. Thus, the Master's degree may now be taken by night; no longer are men required to take daytime courses.

Incidentally, RCA Institutes starts a course in television this fall; New York YMCA school has a course in electronics taught by Ralph H. Batcher.

► **RECORDINGS . . .** A marked development of the science of recording sounds on tape, on disc, on steel, on celluloid, on acetate coated rolls of paper has occurred in recent years. In this issue of *Electronics* appears an article on recording on steel tape. On September 1, station WQXR in New York City broadcast Act I of "Carmen," taken from a 7-mm cellulose tape on which the program was recorded by sapphire stylus. In a suburb of New York City, Count von Medala, one of the early workers in the recording art, demonstrates a simple method of recording and of immediate play back by cutting sound tracks on 16-mm film, 30 tracks being engraved on a single film width. In Washington, and elsewhere probably, entire court proceedings are being "taken down" on various record-

ing media, individual bits of testimony being rushed to the transcribing people who divide it up and put it into typewritten matter as fast as the words are emitted in the courtroom.

In the court the advantages are that several transcribers can work on the record simultaneously and the fact that the actual voices of those giving testimony are mechanically recorded; there is no chance of a stenographer's error; and the testimony may be played back at any time.

► **DATES . . .** The important Fall dates are those of the Rochester Fall Meeting. This year they come on November 14, 15 and 16. The October issue of *Electronics* will contain the technical program—but judging from past performances, there is no need to wait until the program is published to make up one's mind about being in Rochester on these dates.

► **SORRY . . .** Every editor knows that he gets best response to an article when it contains an error. Therefore we are gratified to say that Mr. Carter's article on the Volume Indicator-Attenuator in July, has stirred up quite a bit of correspondence. Mr. Hollis Baird of 1XAL, however, states that the caption to Fig. 3 is practically all wrong; that the circuit won't measure harmonic output from transmitters. We believe Mr. Baird is correct. Mr. Carter made no such claims; we wrote the caption. Where we got the idea it would measure distortion we don't know, but forget it. Mr. Carter has discovered a more serious error, and as a result many letters have gone to him directly. It seems that resistor R-10 in the circuit of Fig. 2 should be returned to the junction of R-11 and R-12 and not to the bottom of R-12 as shown.



# Only **MALLORY** Vibrators offer *all* these advantages

- 1 **Low initial starting voltage** maintained over useful life of vibrator, without sacrifice of operating performance.
- 2 **Exceedingly long life** with practically no decrease in output. Impartial life tests at foremost set manufacturers prove this to be true. That's why Mallory Vibrators are being chosen as original equipment in so many sets.

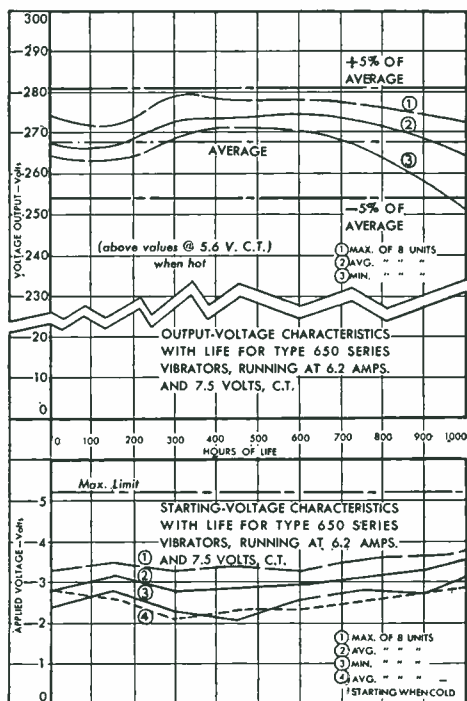

- 3 **Substantially constant reed amplitude** over wide range of battery voltages. Eliminates all possibility of reed breakage.
- 4 **Low mechanical noise.**
- 5 **Lower vibration level.**
- 6 **Permanent alignment of component parts** and reduction of unwanted vibrations.
- 7 **Long life** obtained through use of highest-grade tungsten contacts — producing a minimum of contact erosion and absolute freedom from "chatter" and "bounce".

Long production experience in building present designs — long inspection experience in testing them — assure uniform high quality. Write for *production-built* samples.

**P. R. MALLORY & CO., Inc., INDIANAPOLIS, INDIANA**  
Cable Address—PELMALLO



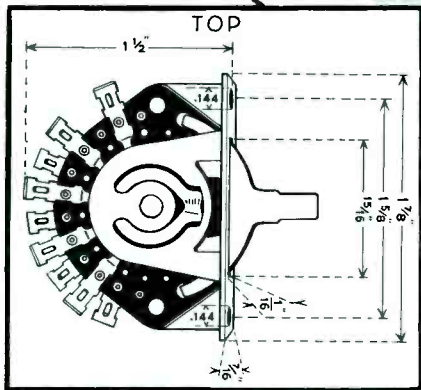
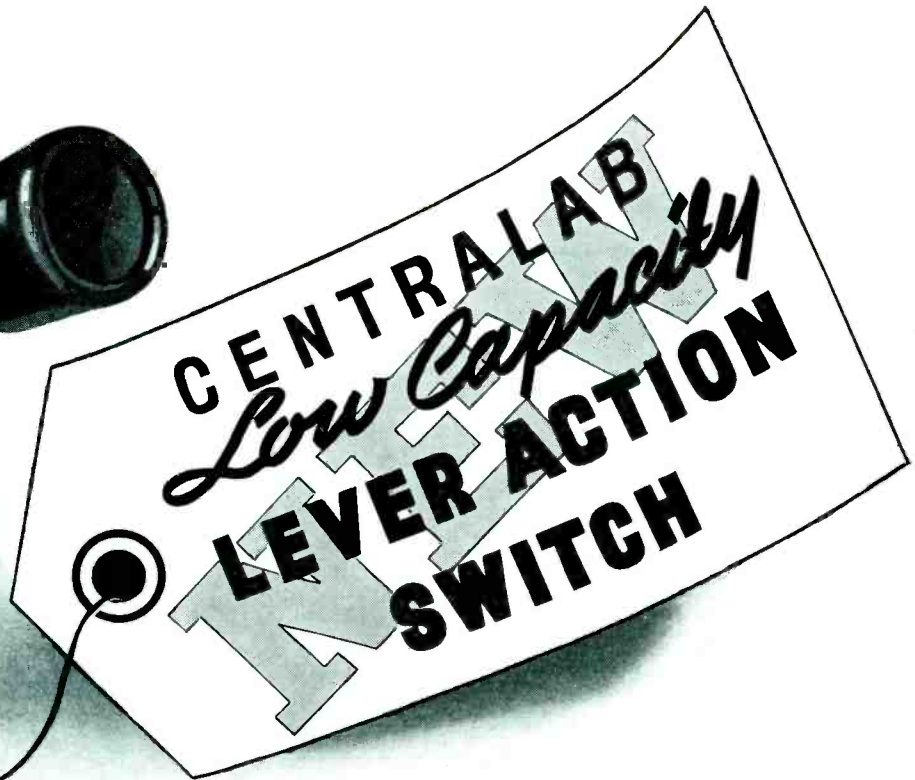
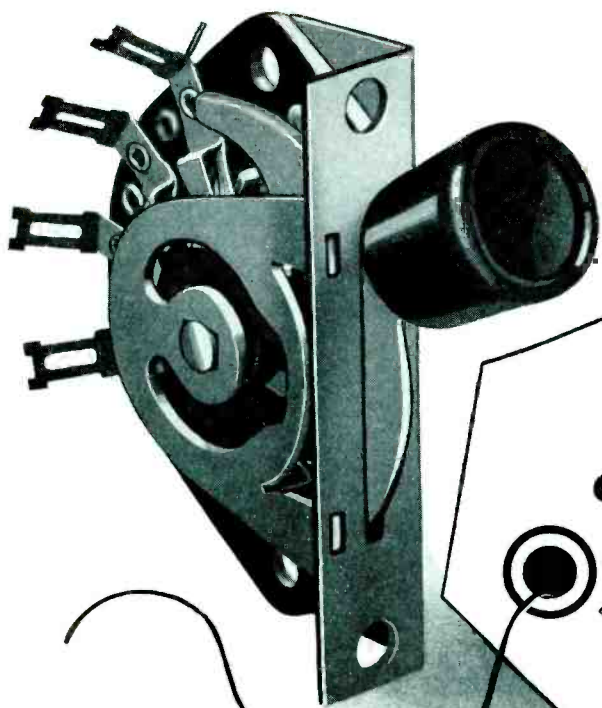

A space-saving lever action switch that can be furnished singly or assembled to an attractive mounting plate with any required number of switches in a group. Each switch will take up to 12 contacts that can be used in countless shorting or non-shorting switching sequences. Contacts are of the long lived double wipe type.

Centralab Lever Action Switches are furnished with either two or three positions. Index action can be positive in all positions, or spring return to center from either side.

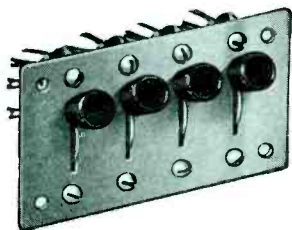

DIVISION OF GLOBE UNION INC., MILWAUKEE, WISCONSIN

*for:*

- **BROADCASTING** In control panels for commercial and amateur transmitters.
  - **RADIO RECEIVING** Band changing, I.F. selectivity, sensitivity, tone, and similar controls.
  - **PUBLIC ADDRESS** Centralized sound, inter-comunicator, call systems.
  - **TEST INSTRUMENTS** Signal generators, analyzers, tube testers, multi-meters.
  - **INDUSTRIAL USE** Electronic apparatus, signalling devices, business machines.
- ... and any other application where multiple contact, low capacity switches are required to operate at low voltages and currents.

ENGINEERS: Send for specification sheet number 628 for further electrical and mechanical details.

# Centralab

CENTRAL RADIO LABORATORIES



# NO TRICKLE FROM NICKEL

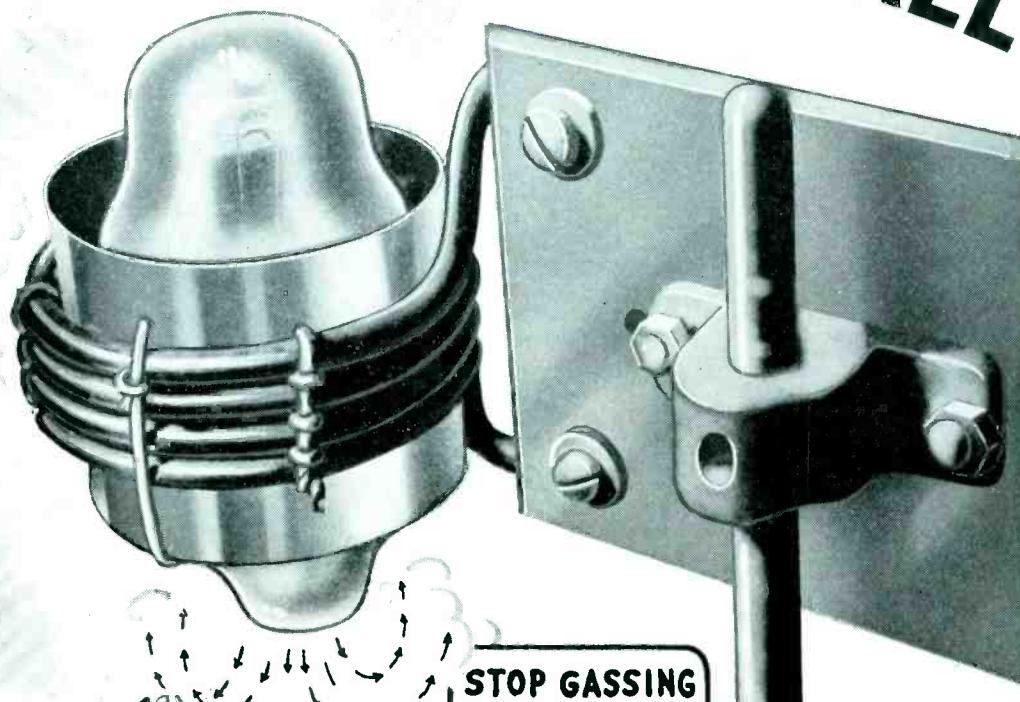

*Two unusual properties in Nickel combine to eliminate "after gassing" from radio tubes*

JUST a slow trickle of gas from metal parts after a tube is sealed... and that's one more tube in the waste can. Or still worse, a tube that soon fails in service. But from parts made of Nickel there's no "after gas", for two reasons:

First, Nickel has a low affinity for gas. As you'll see by the chart shown at right, its gas content is *less than one-tenth* that of iron. Second, to do a better job of removing gas during bombardment, much higher temperatures can be employed for Nickel than for iron or steel.

So with less gas to begin with, and higher permissible exhausting temperatures, Nickel gives up its gas more quickly, easily and completely. As a result, gas does not bleed into tubes after sealing — which means

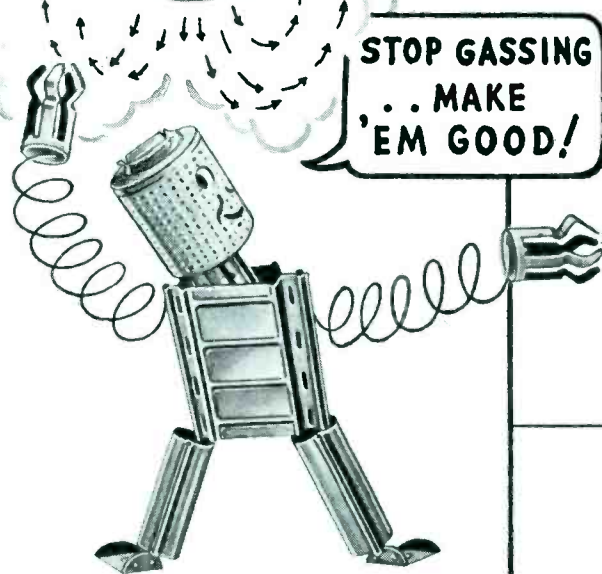

STOP GASSING... MAKE 'EM GOOD!

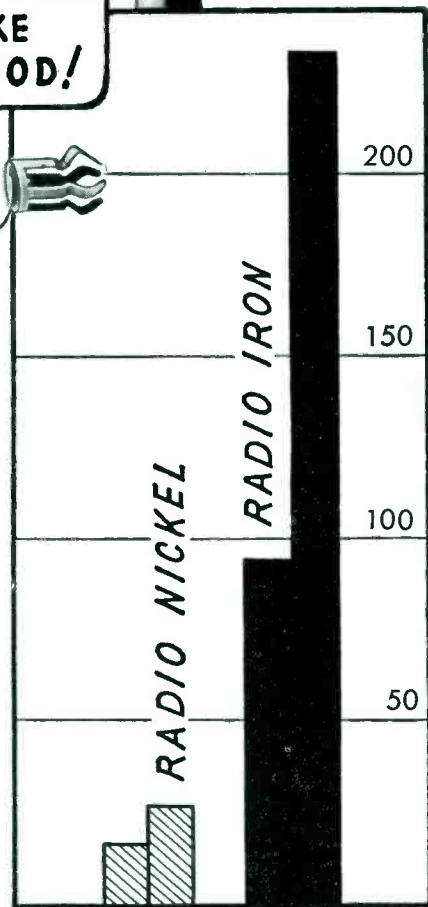

GAS CONTENT—mm 3/gm N. T. P.

fewer rejections, more dependable service, longer lived tubes and better reputation for the tube maker.

Just as Nickel's low gas content and strength at high temperature combine to help the tube maker, so can other properties of Nickel and Nickel alloys combine to help you. Write for technical information, and for your copy of "Nickel in the Radio Industry". Address "Electrical Research", c/o

**THE INTERNATIONAL NICKEL COMPANY, INC., 67 WALL ST., NEW YORK, N. Y.**



**CAN'T DROP OFF!**

# WASHER AND SCREW

- SAVES TIME... ● SAVES MONEY...
- PROTECTS PRODUCT PERFORMANCE

U. S. PATENT Nos. 1,782,387—1,788,735—1,850,242—1,963,800—2,113,424—2,113,425. Other United States and foreign patents pending.



## SHAKEPROOF LOCK WASHER COMPANY

Distributor of Shakeproof Products Manufactured by Illinois Tool Works

2539 North Keeler Avenue, Chicago, Illinois

IN CANADA: Canada Illinois Tools, Ltd., Toronto, Ont.

Copyright, 1938 Illinois Tool Works



# SHAKEPROOF

*announces*

# SEMS

TRADE MARK

The Patented

# PRE-ASSEMBLED LOCK

CONSIDER THESE  
IMPORTANT ADVANTAGES

## COST CONTROL

SAVES  
ASSEMBLY  
OVERHEAD



SAVES  
ASSEMBLY  
LABOR



PREVENTS  
LOST LOCK  
WASHERS



## PRODUCT CONTROL

ASSURES CORRECT  
WASHER FOR EACH  
TYPE OF SCREW  
HEAD



ASSURES A  
LOCK WASHER  
UNDER EVERY  
SCREW





# QUESTION:

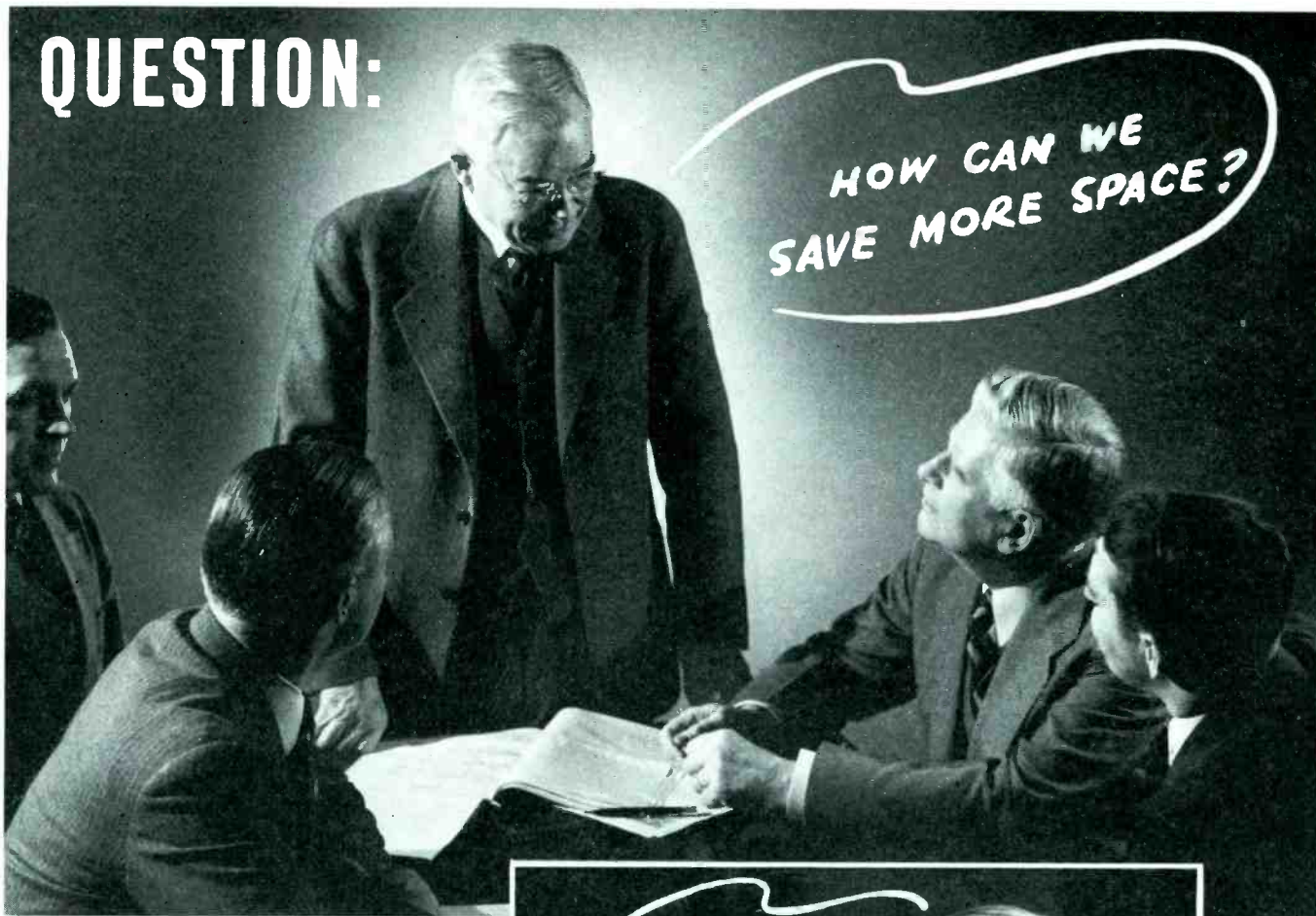

HOW CAN WE  
SAVE MORE SPACE?

# ANSWER:



**SOCKET 6708—8 CONTACTS ACTUAL SIZE**  
*save space* with the new Cinch "Cub".  
 For octal tubes  $1\frac{5}{16}$ " mounting  
 centers . . . where set space is at a premium  
 —this socket with *improved* individual  
 features will find a ready use. Samples  
 and further detail on request.

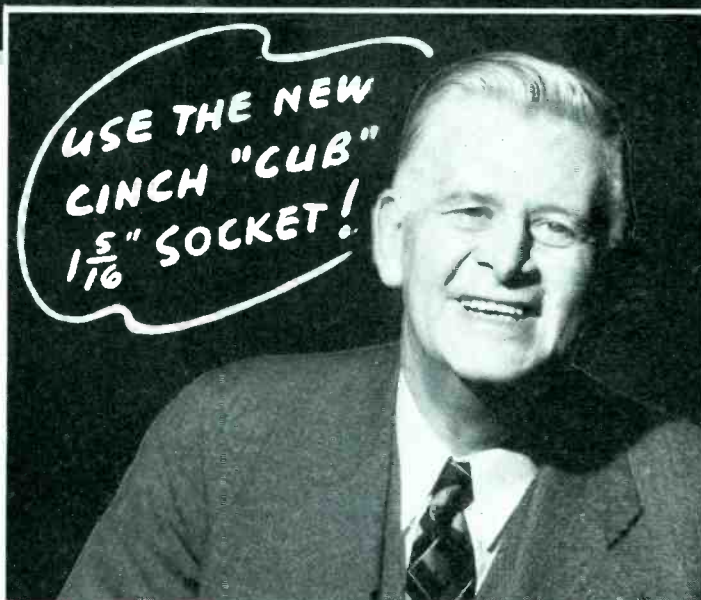

USE THE NEW  
CINCH "CUB"  
 $1\frac{5}{16}$ " SOCKET!

## THERE IS A CINCH SOCKET FOR EVERY TYPE OF RADIO RECEIVER TUBE

Efficient design—contact spacing  
 arranged so as to allow maximum  
 mechanical and electrical efficiency:  
 CINCH sockets in use have proved

to be time—money—and *space savers*.  
 Rigid, durable, compact and trim. Im-  
 mediate delivery! Specify "CINCH"  
 . . . and insure good performance.

Cinch and Oak Radio Sockets are licensed under H. H. Eby socket patents.

**CINCH** MANUFACTURING CORPORATION  
 2335 WEST VAN BUREN STREET, CHICAGO, ILLINOIS  
 SUBSIDIARY OF UNITED CARR FASTENER CORPORATION, CAMBRIDGE, MASS.



# FLEXIBLE SHAFTS can be used to advantage in HOME RADIOS

Remote control of tuning elements with flexible shafts is a principle of design that offers several worth while advantages for home radios.

An effective application of the principle is furnished by the RCA Broadcast Transmitter illustrated. See how *the use of flexible shafting makes it possible to place all elements that require tuning in the optimum position with respect to the circuit, and at the same time, to locate control knobs for maximum operating convenience.*

It is quite obvious that this principle can be applied with equal advantage to home radios, and that its use *removes all restrictions to cabinet design.* It permits radio stylists to indulge their ingenuity to the limit and at the same time allows tuning elements to be located in positions that best satisfy the requirements of circuit efficiency, economical assembly and servicing convenience.

## SEND FOR ENGINEERING BULLETIN 38

*It gives full details about S. S. WHITE Flexible Shafts, specially developed for applications of this character. A request on your business letterhead brings you a free copy. Write for it, today.*

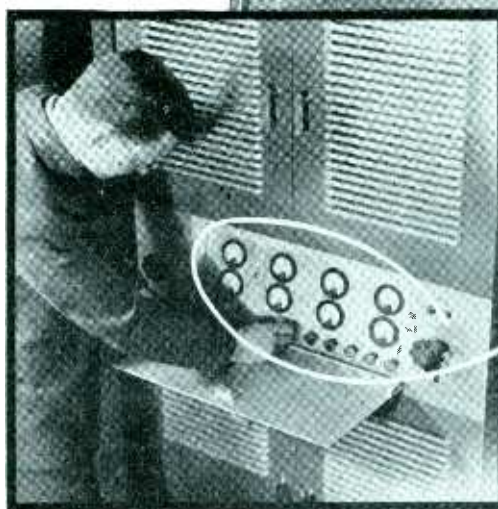

*These front and back views make clear the value of flexible shafting in radio design. Photos courtesy of RCA Manufacturing Co., Inc., Camden, N. J.*

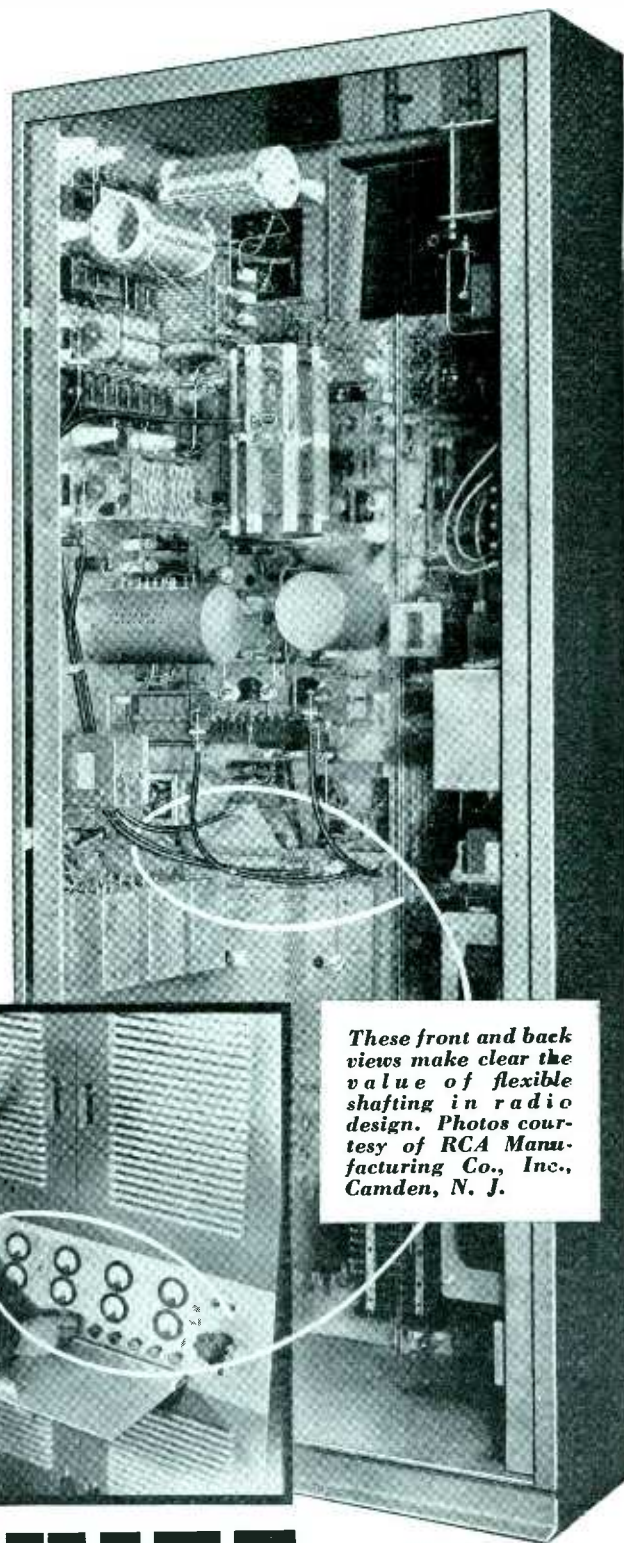

# S. S. WHITE

The S. S. White Dental Mfg. Co.

---

**INDUSTRIAL DIVISION**

---

Department E, 10 East 40th St., New York, N. Y.

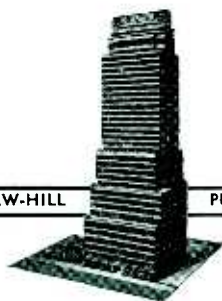

A McGRAW-HILL PUBLICATION

# electronics

CONTENTS—SEPTEMBER, 1938

RADIO . . . COMMUNICATION AND  
INDUSTRIAL APPLICATIONS OF  
ELECTRON TUBES . . . DESIGN . . .  
ENGINEERING . . . MANUFACTURE

KEITH HENNEY

Editor

DONALD G. FINK

Managing Editor

BEVERLY DUDLEY

Associate Editor

HARRY PHILLIPS

Art Director

H. W. MATEER

Manager

ELECTRONICS, September, 1938, Vol. 11, No. 9.  
Published monthly, price 50c a copy. Subscription  
rates—United States and possessions, Canada,  
Mexico and Central American countries, \$5.00 a  
year. All other countries, \$6.00 a year or 24  
shillings. Entered as Second Class matter, August  
29, 1936, at Post Office, Albany, N. Y., under  
the Act of March 3, 1879.  
Branch Offices: 520 North Michigan Ave., Chicago;  
883 Mission St., San Francisco; Aldwych House,  
Aldwych, London, W. C. 2; Washington; Phila-  
delphia; Cleveland; Detroit; St. Louis; Boston;  
Atlanta, Ga.

Contents Copyright, 1938, by  
McGraw-Hill Publishing Company, Inc.

McGRAW-HILL  
PUBLISHING COMPANY, INC.

JAMES H. MCGRAW

Founder and Honorary Chairman

Publication Office

99-129 North Broadway, Albany, N. Y.

Editorial and Executive Offices

330 West 42nd Street, New York, N. Y.

James H. McGraw, Jr., President

Howard Ehrlich, Executive Vice President

Mason Britton, Vice Chairman

B. R. Putnam, Treasurer

D. C. McGraw, Secretary

A. W. Morrison, Circulation Manager

Cable Address:

MCGRAWHILL, New York

Member A.B.P. Member A.B.C.

INSULATORS FREE FROM RADIO INTERFERENCE.....	Cover
Radio-proofing Westinghouse pin type insulators by means of a newly developed copper-oxide glaze which maintains good contact between the wire and insulator to eliminate charging current arcs	
EFFERVESCENCE .....	Frontispiece
Glass beads used in radio tube manufacture being examined at RCA Manufacturing Radiotron plant	
A CONSULTANT ON ELECTRONICS, by Rex D. McDill.....	11
Trials and tribulations of the free-lance engineer working in the field of electron tubes as applied to industrial control problems	
ELECTRONICS HELPS MAKE BEER.....	13
Photographs of an installation of photoelectric counting apparatus in a brewery where cases are accurately totaled	
SOUND EFFECTS PRE-AMPLIFIER, by C. F. Sheaffer.....	14
By a series of anti-resonant circuits various and curious effects may be created for broadcast usage	
D-C VOLTMETER WITH FEEDBACK, by J. M. Brumbaugh and A. W. Vance.....	16
Applying negative regeneration to a vacuum tube voltmeter produces an instrument of extreme sensitivity	
COLOR MATCHING IN PAPER INDUSTRY, by E. C. Deeter.....	18
Phototube device for determining color of samples by reflected or transmitted light. Used for matching printing ink colors	
COMBINATION TONES IN NON-LINEAR SYSTEMS, by Frank Massa .....	20
Trigonometric power series analysis, with experimental measurements to show that distortion is greater when several frequencies are present than when only a single frequency is present	
A LABORATORY TELEVISION RECEIVER, III, by Donald G. Fink	22
Design and construction of vertical sweep circuits. Testing, scanning pattern characteristics, and circuits for separating sync signals	
SINGLE-ENDED R-F PENTODES, by R. L. Kelly and J. F. Miller..	26
New construction of r-f pentodes eliminates top-cap, decreases leakage, gives higher gain, and results in simpler and neater wiring	
INDUSTRIAL TUBE TERMINOLOGY.....	29
Trade names of tubes used in industrial practice, classified according to construction and function	
WHAT ABOUT MAGNETIC RECORDING? By S. J. Begun.....	30
Discussion of virtues of recording on magnetic material with description of apparatus available, and applications	
ELECTRONIC VOLTMETER USING FEEDBACK, by Stuart Ballantine .....	33
A-c operated vacuum tube voltmeter using negative feedback with voltage ranges, logarithmically related	

## DEPARTMENTS

CROSSTALK .....	9
REFERENCE SHEET .....	29
TUBES AT WORK.....	36
ELECTRON ART .....	54
THE INDUSTRY IN REVIEW.....	60
PATENTS .....	73
NEW BOOKS .....	80
INDEX TO ADVERTISERS .....	84



# ENDED R-F PENTODES

lowed that shielding of the leads in the zone between the mount proper and the glass seal could be minimized. That this was true proved fortunate because numerous welding operations take place in this rather limited space during the assembly of tube parts, and shielding would, therefore, be awkward and expensive.

Shielding between leads in the glass of the stem has been accomplished by inserting a conical-shaped piece of metal in the opening in the glass "button" provided for exhaust purposes. This cone conforms closely to the shape of the exhaust opening for maximum shielding effectiveness and is held in place and grounded by welding it to the shell lead. The cone is of sufficient length to extend

ing is maximum between two leads when they are diametrically opposite in the base-pin circle. The capacitance measured between two such leads is less than  $0.0002 \mu\text{f}$ . The shield in the base locating lug is equally effective in shielding the socket terminals of the conventional wafer socket. Since this capacitance between socket terminals is also at a minimum for opposite pins, the conventional basing arrangement was revised for the pentodes to place the control grid and plate leads opposite one another.

The single-ended construction of these new tubes lends itself well to radio-receiver designs and offers distinct advantages over the usual top-cap construction. The fact that the

amplifier and converter tubes often causes regeneration which becomes quite a serious problem when the gain of the amplifier is high. It is frequently necessary to place a shield between the two grid leads in order to obtain more stable amplifier operation. In designs which do not use a shield, the physical relation of the two grid leads affects the amount of regeneration present and any change in the relative position of the two leads will change the gain of the amplifier.

These developmental pentodes afford a simple solution to this problem. Since the grid lead of each type is brought out to a pin in the base of the tube, the lead connecting the grid to the input circuit may be made of

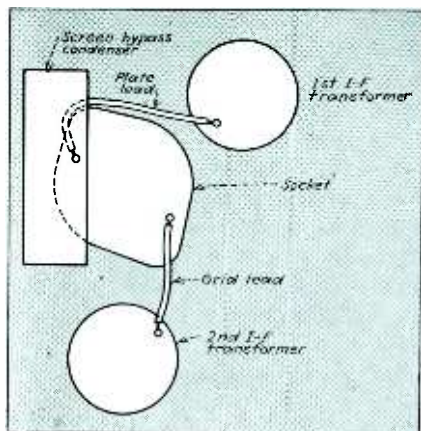

Fig. 2—Long grid and plate leads in conventional superheterodyne circuit

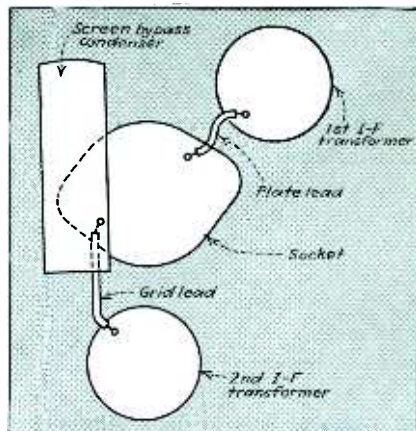

Fig. 3—Grid and plate leads shortened by rotating tube socket through  $90^\circ$  angle

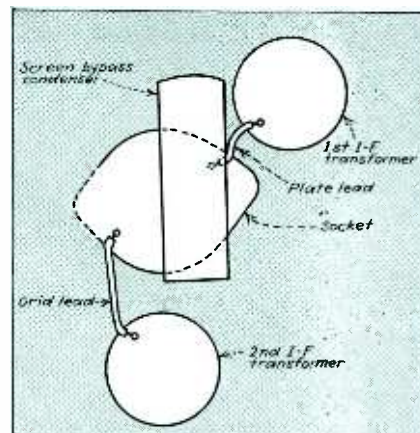

Fig. 4—Leads to by-pass may be reduced in length by properly positioning condenser

partially into the exhaust tube proper. To shield the base pins one from the other, a cylindrical piece of metal is used and shaped to conform to the inner dimensions of the locating base plug. This shield is grounded by a lead that extends into the shell pin of the base, the connection being soldered at the time the tube is based. Shield and lead are in one piece and are rather easily stamped and formed. Fig. 1 is a pictorial representation of both shields as positioned relative to other parts of the tube. It should be noted that the two parts overlap for complete shielding; the stem cone extends into the shielding range of the base insert.

The effectiveness of this shield-

flexible lead connecting the control grid to its associated circuit is no longer required, results in elimination of loose or broken grid connectors and leads, simplification of tube renewal, cleaner appearance of chassis, more stable amplifiers, greater uniformity of gain in amplifiers, and lowered cost.

It is well known that capacitive coupling between the input circuits of two successive amplifier tubes operating in cascade causes regeneration, and when sufficient coupling is present produces actual oscillations. In conventional radio receivers having a radio-frequency amplifier ahead of the converter stage, the capacitance coupling between the grid leads of the

stiff wire and thus fixed in position. In addition, the proximity of the metal chassis to the lead affords additional shielding of the lead. The reduction in this feedback capacitance makes possible the use of a tube design having greater amplification. Moreover, because the coupling capacitance is not variable, variations in gain are minimized.

The improvement due to the new design is illustrated by the results of the following test. One of the single-ended pentodes was put in the radio-frequency stage of a popular commercial automobile receiver. The amplifier, using a conventional tube, had a gain of 30. The gain with the new single-ended tube was 45,

TABLE OF TENTATIVE AVERAGE CHARACTERISTICS, SINGLE-ENDED TYPES

	Develop. Type Similar to 6K7	Develop. Type Similar to 6J7	Develop. Type Similar to 6F5	Develop. Type Similar to 6Q7
Heater Voltage.....	6.3	6.3	6.3	6.3
Heater Current, in Amperes.....	0.3	0.3	0.3	0.3
Direct Interelectrode Capacitances in $\mu\mu\text{f}$ .*				
Grid to Plate (max.).....	0.005	0.005	—	—
Input ( $G_1$ to H + K + $G_2$ + $G_3$ ).....	6.0	6.0	—	—
Output (P to H + K + $G_2$ + $G_3$ ).....	7.0	7.0	—	—
Operating Conditions and Characteristics:				
Plate Voltage (max.).....	250	250	250	250
Screen Voltage (max.).....	100	100	—	—
Grid Voltage.....	-3 min.	-3	-2	-2
Suppressor.....	Connected to cathode at socket			
Amplification Factor.....	1600	2500	100	100
Plate Resistance, in megohms.....	0.8	1.5	0.066	0.091
G-P Transconductance, in $\mu$ mhos.....	2000	1650	1500	1100
Plate Current, in ma.....	9.2	3.0	0.9	0.8
Screen Current, in ma.....	2.4	0.8	—	—

\* With shell connected to cathode.

with good stability. However, when a tube, like the new one except that the grid was connected to a top cap in the conventional manner, was placed in the amplifier, oscillation occurred when the amplifier and converter grid leads were as much as one inch apart. Moving them one and one-half inches apart stopped the oscillation but a shield between the two leads was required in order to stabilize the amplifier.

In another test, the developmental single-ended pentodes were substituted for conventional top-cap types in a small four-tube, tuned-radio-frequency receiver of popular design. An improvement in the uniformity of sensitivity throughout the tuning range was realized, due to the reduction of regeneration. The reduction in regeneration was affected by the improved shielding of the grid leads due to their proximity to the metal chassis. A substantial improvement in sensitivity at the low-frequency end of the range, where regeneration was negligible, was also realized because of the increased transconductance of the new tubes.

When the grid-plate transconductance of any tube is increased, whether it be a radio-frequency amplifier, audio-frequency amplifier, or power output tube, some special precautions are in order if full advantage of the increased transconductance is to be realized.

When these new tubes are used in intermediate-frequency amplifiers of present receiver designs, it may be necessary to modify the interstage transformers to obtain optimum operation. The  $L/C$  ratio of the modi-

fied transformers should be lower (in order to have lower impedance) and, thus, maintain the same degree of regeneration in the receiver without a change in the selectivity. This change may not be necessary in receivers having only a small amount of regeneration initially, but will be quite essential in receivers having high-impedance transformers and operating with considerable regeneration present.

Bringing the grid lead of the interstage transformer down to the bottom of the unit may change the capacitance coupling of the two circuits, and thus affect the gain and selectivity of the stage. In such cases it will be necessary to change the inductive coupling of the transformer slightly to correct for this condition.

In the design of amplifiers using conventional tubes, it is necessary to give consideration to the mechanical layout of the component parts in order to reduce feedback effects. Since both the grid and plate leads of the single-ended tube terminate beneath the chassis, the use of the single-ended type may require that further attention be given to the arrangement of the component parts for best results. Figs. 2 and 3 illustrate this point. In Fig. 2 the socket and intermediate-frequency transformers are mounted in such a way as to necessitate rather long grid and plate leads as indicated. Fig. 3 shows the revised mounting where the socket and input transformer have been rotated through  $90^\circ$ . It is readily seen that this arrangement leads to very short grid and plate leads. Measurements of the effective grid-plate

capacitance were made for the two conditions illustrated and showed a reduction from a value of  $0.006 \mu\mu\text{f}$  to a value of  $0.0046 \mu\mu\text{f}$ . This reduction improved the stability of the amplifier.

It has been found that additional shielding which also reduces the effective grid-plate capacitance, may be obtained by placing the screen by-pass condenser close to and across the tube socket. Fig. 3 illustrates this positioning of the by-pass condenser, and may be compared to Fig. 4. Measurements of the effective grid-plate capacitance for the two positions of screen by-pass condensers were made and reduction from  $0.0046 \mu\mu\text{f}$  to  $0.0038 \mu\mu\text{f}$  was found. The stability of the amplifier was further increased by this change.

The effect of the kind of socket on the input circuit was investigated and results indicate that wafer-type sockets in general are entirely satisfactory for tubes of the single-ended design. The dielectric losses are the important considerations. Moulded types of sockets, in general, exhibit wider variations in the loading characteristic but socket manufacturers are improving their designs to provide for their use with tubes of the single-ended type.

Measurements have been made of the loading produced in the input circuit by tubes and socket components. These results, together with the calculated reduction in gain are shown for a frequency of 450 kc. and a wafer-type socket.

Component	Conductance in micromhos	Shunt Resistance in megohms	Reduction in gain*
Socket	0.06	16.5	1.2%
Base	0.09	11.0	1.7%
Unbased Tubes	0.07	14.0	1.4%
All components	0.22	4.5	4.3%

\* Value calculated for input circuit impedance of 0.2 megohm.

From the above table, it is readily seen that for typical i-f circuits the loss in gain due to all components is less than 5% and the loss due to the base and socket is less than 3%. These losses, when compared to those of conventional top-cap metal tubes, are more than offset by the improved gain provided by the high transconductance of the single-ended design.



# Industrial Tube Terminology

Names and definitions of tube types employed in industrial electronics, arranged according to type of space employed, cathode, and control structure, compiled by the General Electric Company as guide to terms in industrial field

Generic Term	Output Energy	Character of Space	Control Means	Type Cathode	Names	Definition
Electronic Tubes (or tanks)	Electrical	High-Vacuum	None	Thermionic	Kenotron	A kenotron is a high-vacuum thermionic tube in which no means is provided for controlling the unidirectional current flow.
				Photoelectric	Phototube	A phototube is a vacuum tube in which electron emission is produced directly by radiation falling upon an electrode. A high-vacuum phototube is one which is evacuated to such a degree that its electrical characteristics are essentially unaffected by gaseous ionization.
		Gas-Filled	None	Electrostatic	Pliotron	A pliotron is a high-vacuum thermionic tube in which one or more electrodes are employed to control the unidirectional current flow.
				Electro-magnetic	Magnetron	A magnetron is a high-vacuum thermionic tube in which a magnetic field is employed to control the unidirectional current flow.
				Thermionic	Phanotron	A phanotron is a hot-cathode, gas-discharge tube in which no means is provided for controlling the unidirectional current flow.
				Cold	Glow Tube	A glow tube is a cold-cathode, gas-discharge tube in which no means is provided for controlling the unidirectional current flow.
				Pool	Pool Tube (or Tank)	A pool tube (or tank) is a gas-discharge tube (or tank) with a pool-type cathode (liquid or solid) in which no means is provided for controlling the unidirectional current flow.
				Photoelectric	Phototube	See phototube definition under "High-Vacuum Tubes". A gas phototube is one into which a quantity of gas has been introduced, usually for the purpose of increasing its sensitivity.
				Thermionic	Thyratron	A thyratron is a hot-cathode, gas-discharge tube in which one or more electrodes are employed to control electrostatically the starting of the unidirectional current flow.
				Electrostatic Electrode	Grid-Glow Tube	A grid-glow tube is a cold-cathode, gas-discharge tube in which one or more electrodes are employed to control electrostatically the starting of the unidirectional current flow.
Light	Ultra-Violet	Gas-Filled	None	Pool	Grid-Pool Tube (or tank)	A grid-pool tube (or tank) is a gas-discharge tube (or tank) with a pool-type cathode (liquid or solid) in which one or more electrodes are provided for controlling electrostatically the starting of the unidirectional current flow.
				Ignition Electrode	Ignitron	An ignitron is a gas-discharge tube (or tank) with a pool-type cathode (liquid or solid) in which an ignition electrode is employed to control the starting of the unidirectional current flow in each operative cycle.
				Electro-magnetic		

**EDITOR'S NOTE:** The names and definitions stated above have not been standardized by NEMA or ASA, but have been offered to these bodies for approval. The list represents a consolidation of the terms employed by the General Electric Company and the Westinghouse Electric and Manufacturing Company, with which companies they are now standard. Both companies have relinquished copyrights to those terms formerly employed as trademarks.

## ELECTRONICS REFERENCE SHEET

# Magnetic Recording

A survey of the distinguishing characteristics of recording on magnetic material, such as steel tape or wire, with a description of a modern machine of this type with suggestions for its application

By S. J. BEGUN

*Acoustic Consultants Incorporated, New York, N. Y.*

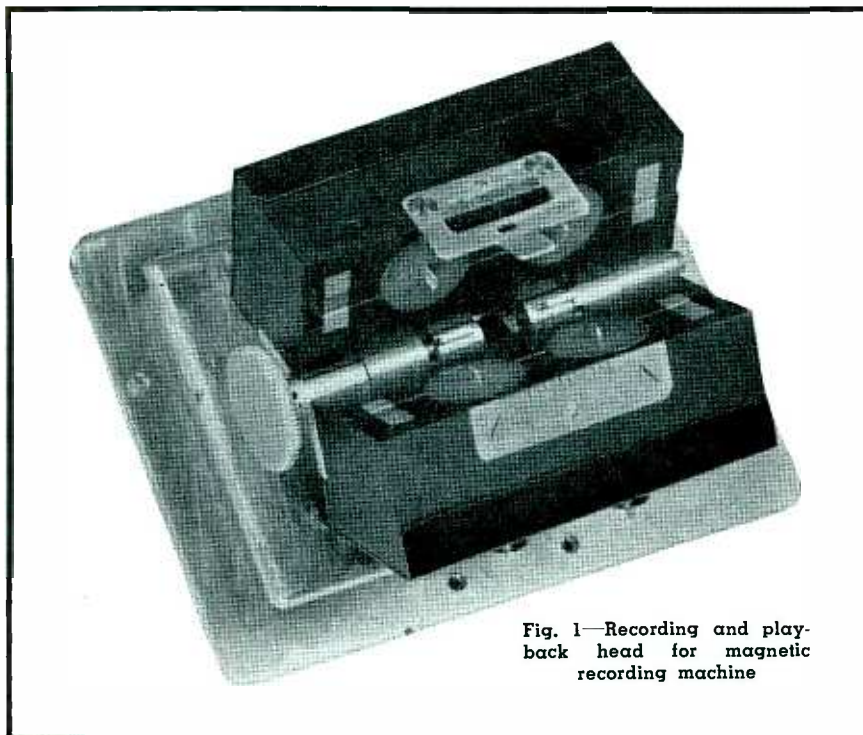

Fig. 1—Recording and playback head for magnetic recording machine

**M**AGNETIC sound recording and reproducing has by now been developed to the same high degree of perfection as the long available mechanical and optical systems. It is, therefore, logical to ask the question what can this method of sound recording add to the art. An answer to this question naturally can only be positive if this third method has something desirable which the two other known methods of sound recording and reproducing do not possess.

The principal of magnetic recording is, so far, very little known in this country. It is the idea of this article to analyze the specific values

of this third method of sound recording and make a comparison with the generally familiar methods.

Magnetic sound recording is done on steel tape and wire. The signal is impressed upon the sound carrier either by perpendicular or longitudinal magnetization. Perpendicular magnetization leaves in the sound carrier magnetic forces rectangular to the motion of the sound carrier, while longitudinal magnetization leaves magnetic forces in the direction of the motion of the sound carrier.

Whether perpendicular or longitudinal magnetization is used, or whether steel tape or steel wire is

employed as a sound carrier, magnetic recording involves three operations.

1. The sound carrier is magnetically prepared for recording by magnetic saturation.

2. The signal is impressed upon the sound carrier by superposition of the action of the signal current on a polarizing current.

3. The signal is reproduced by exciting a pickup with the magnetic forces of the record.

Usually an identical magnetic head is used for saturating, recording, and reproducing. As shown in Fig. 1, such a magnetic head consists of two sets of coils and pole pieces touching or closely placed on the opposite sides of the sound carrier. If perpendicular magnetization is employed, the pole pieces are aligned; for longitudinal magnetization, the pole pieces are slightly offset.

Magnetic recording has these distinguishing characteristics:

1. The record impressed upon the sound carrier may be obliterated by a simple electro-magnetic process.

2. Frequent rerecordings are possible since the impression of a signal affects only the magnetic structure of the sound carrier.

3. Extensive tests have established that the same record on a magnetic sound carrier may be reproduced an infinite number of times. In these tests a magnetic sound record on a magnetic tape was reproduced for more than 300,000 times, with the results shown in Fig. 2. It is seen that the signal level decreased 3 db during the first 20,000 reproductions, and that the total signal loss approached an asymptotic value of 4.5 db.

4. The recording and reproducing operations are not affected by vibrations and mechanical shocks. This is due to the fact that the adjustment



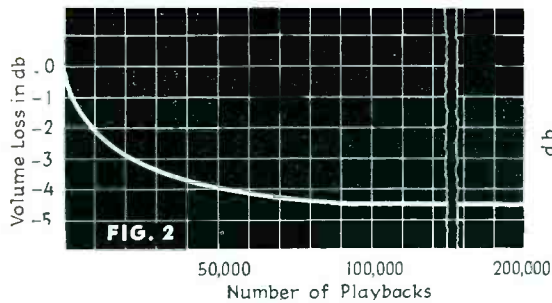

Fig. 2—Effect of continued playings on volume

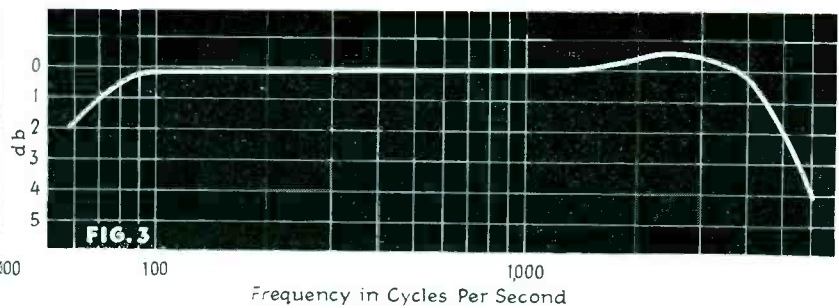

Fig. 3—Overall frequency response of the BBC recording machine

of the pole pieces is not very critical. The alignment between sound carrier and pole pieces can be taken care of even if the mechanical system driving the sound carrier is exposed to most severe mechanical vibration. No other system of reproducing is known which can stand such severe vibrations.

5. Specially developed pole pieces eliminate all problems of wear and tear during prolonged recording and reproducing operations. This was established in extensive tests carried out with a short endless tape loop; the ends were joined by brazing. The loop was played over one million times without any observable change in the pole pieces or brazed joint and without affecting the mechanical and magnetic characteristics of the tape.

Magnetic recording combines these unique advantages with a high quality of reproduction meeting all practical requirements. This is borne out in a recent article<sup>1</sup> describing a magnetic broadcasting machine of the British Broadcasting Corporation which has an overall response curve shown in Fig. 3. This overall response is considerably improved by the specially developed pole pieces.

The signal can be recorded at least 40 db above noise level and in this respect magnetic recording matches the best other methods.

In addition, a magnetic recording machine enables flutter-free recording and reproduction of even piano music. Such a machine developed for objective study of music, voice, and languages is shown. Four guide rollers are mounted in the corners of a frame structure. An endless magnetic tape is helically wound around these four

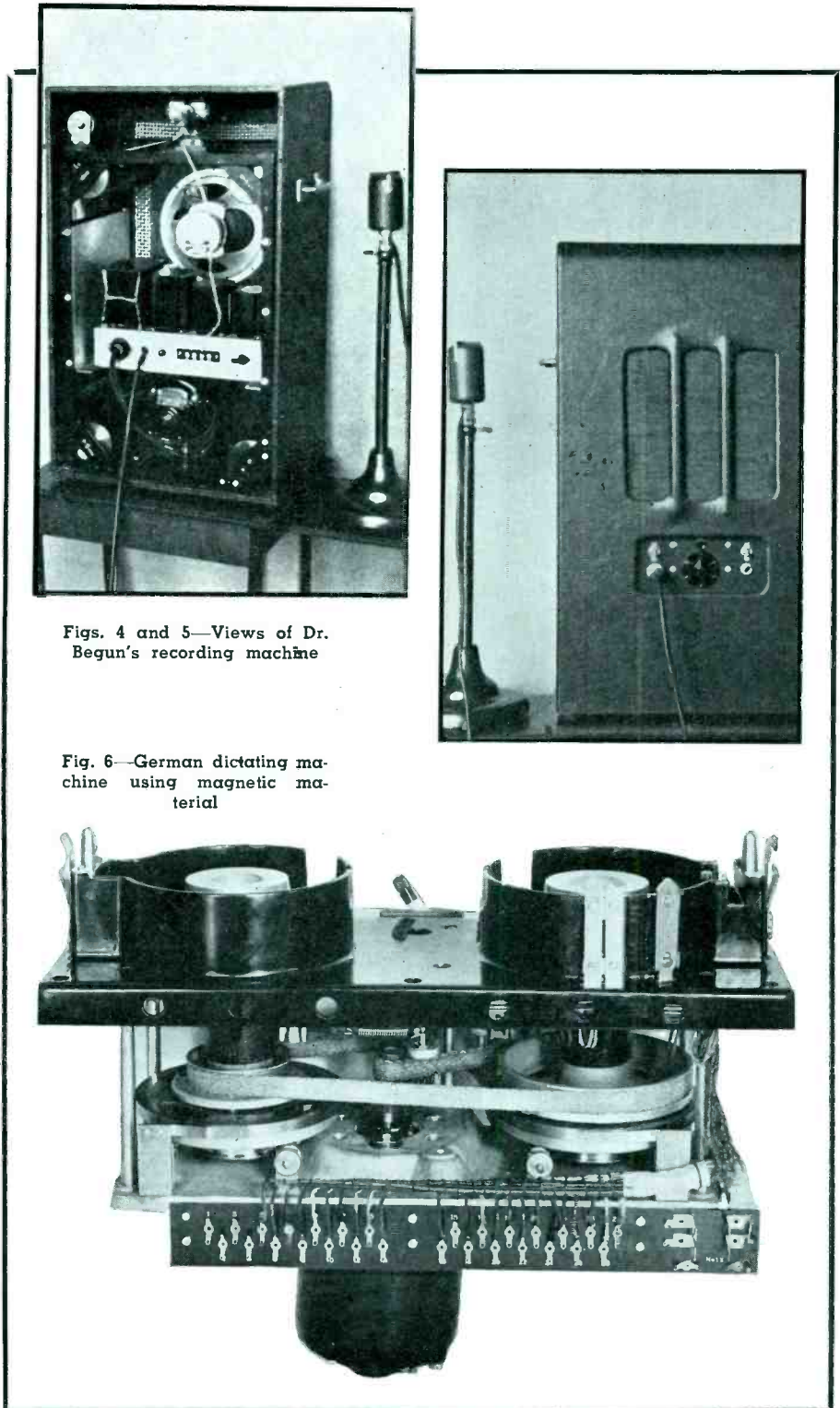

Figs. 4 and 5—Views of Dr. Begun's recording machine

Fig. 6—German dictating machine using magnetic material

<sup>1</sup>"Some Aspects of Magnetic Recording and its Application to Broadcasting," *The Institution of Electrical Engineers*, Vol. 82, No. 495, March, 1938, by A. E. Barrett and C. J. F. Tweed.



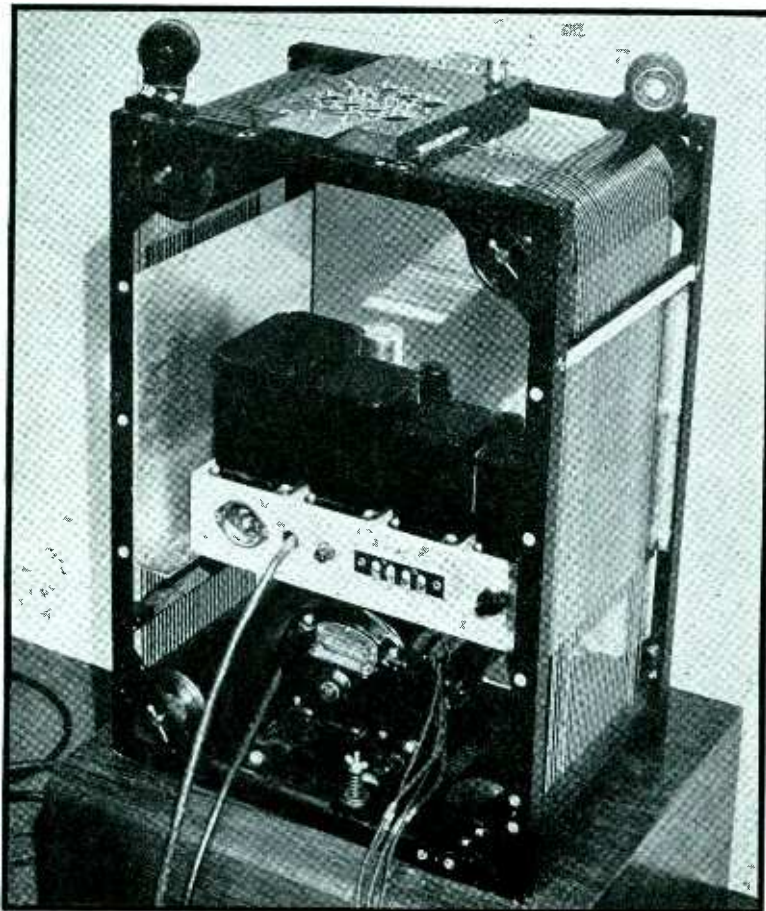

Interior of Dr. Bequn's recording machine

guide rollers. The first and the last loop on the guide rollers are joined together over two cross-over rollers.

A resiliently mounted motor drives through a belt one of the guide rollers. The sound carrier is frictionally engaged with the four guide rollers so that the three idle rollers have the effect of fly wheels and any irregularity of speed of the motor driven roller will be compensated by the three idle rollers. Guide bars mounted in front of the rollers maintain the proper spacing of the individual tape loops.

The cabinet enclosing the magnetic recorder also houses the amplifier and speaker. The endless tape may be made sufficiently long to give a recording time of from fifteen seconds to several minutes. Recording and reproducing is controlled by a simple push-button operation. After pressing the button, the machine will record until the sound carrier has completed one cycle. Then the record will be automatically reproduced as many times as desired, giving the student an opportunity to study his recording. The user does not require experience or technical skill for making recordings.

European broadcasting unit using steel tape

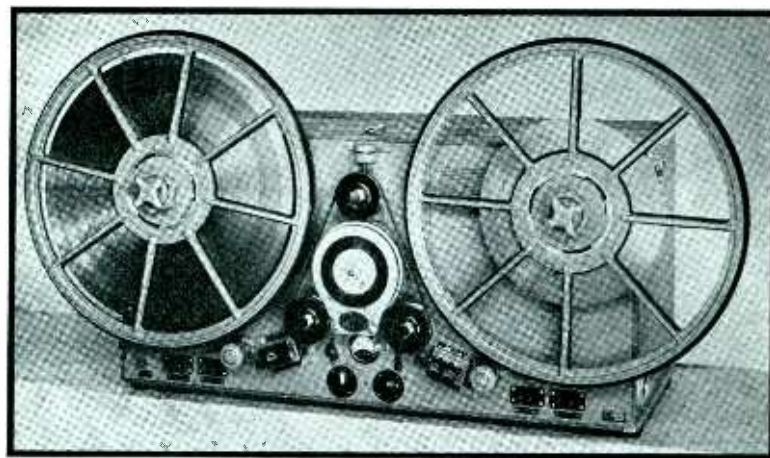

A machine of this type lends itself for a variety of applications by using a number of displaced magnetic heads and suitable attenuating and mixing networks. For example, such a machine can be used as a flexible synthetic reverberation apparatus that will solve the problem of adding

acoustic liveliness for which film and broadcasting studios now require expensive and cumbersome reverberation chambers. Its flexibility permits control of the reverberation effects in accordance with special needs and the production of echo effects.

Such machines may also be used in combination with display advertising to describe the products shown either in a moving or a continuously changing exhibit. The flexibility of magnetic recording permits the quick substitution of a new message and an infinite number of playbacks of the recorded message. The machine may be combined and synchronized with a picture-changing mechanism. Such a machine is also useful for sending out warning signals such as weather reports, S.O.S. signals, burglar alarms. An endless magnetic recording machine may be combined with a short wave transmitter tuned for the police radio wave length so as to announce the location and tell that a burglary has taken place or that a fire has broken out.

Magnetic recording is also ideal for use as a dictating machine and other business applications. A photo is shown of the driving mechanism of a magnetic wire dictating machine which is displacing in Germany the wax cylinder dictating machines. An exchangeable magnetic wire spool arranged for quick mounting on the

top of the machine is not shown.

The foregoing applications show that all problems connected with the manufacture of practical magnetic recording machines have been solved, and that nothing can prevent its finding wide industrial and educational applications.



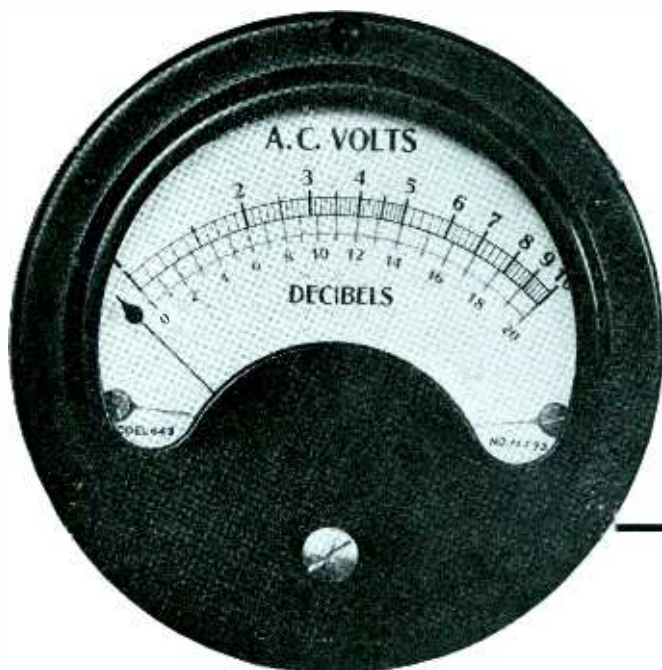

# ELECTRONIC VOLTMETER Using Feedback

By **STUART BALLANTINE**

*Ballantine Laboratories, Inc.,  
Boonton, N. J.*

**T**HE VACUUM tube a-c voltmeter has become one of the most useful instruments in the electrical and communication laboratory. Its high input impedance and the wide frequency range which may be covered by proper design give it a considerable advantage over the older types of indicating instruments. Its sensitivity is limited however to a few tenths of a volt, which is insufficient for many measurements in communication and other branches of "weak current" engineering. Another disadvantage is the non-linearity of the scale for small voltages, which restricts the useful scale length and in multi-range instruments necessitates the use of several scales. For most purposes the ideal scale is a logarithmic one reading from 1 to 10. With such a scale the percentage of error of reading is uniform over the entire scale, and a uniform decibel scale can be provided for those applications where it is desirable to express results in decibels. The various voltage ranges can be made multiples of 10, which permits the use of a single scale for all ranges, and eliminates the optical confusion of the conventional multi-range instrument.

The instrument to be described here was developed several years ago to overcome these disadvantages. It is about one hundred times as sensitive as the conventional electronic



Fig. 1—Above. External view of the electronic voltmeter

Fig. 6—Upper Left. Scale showing logarithmic calibration of voltmeter, and auxiliary decibel scale

meter, permitting readings down to 0.001 volt. Its upper limit is 100 volts, which is equal to that of most multi-range vacuum-tube instruments. This high sensitivity permits it to be used to read voltages which heretofore have required amplification prior to measurement. For example, a very satisfactory sound-

meter can be obtained merely by connecting a calibrated microphone to its terminals, no intermediate amplification being necessary. The frequency range extends from 10 cycles to 100,000 cycles, which completely covers the audio range, the frequencies used in supersonic signalling and the range of a large number of carrier communication systems. By connecting the instrument across suitable resistors a very sensitive ammeter is obtained and currents can be measured which are thousands of times smaller than can be measured with ordinary sensitive vacuum thermo-couples or rectifier instruments.

### *Principles of Operation*

The instrument is entirely self-contained, is a-c operated, and readings are independent (within 1%) of line voltage from 110 to 120 volts. The scale is calibrated in root-mean-square values of a sinusoidal wave. Readings are accurate to within 2% over most of the range. An external view of the voltmeter is shown in Fig. 1.

The instrument comprises essentially a multistage amplifier, diode rectifier and a special d-c meter in which the deflection is proportional to the logarithm of the current. In addition a feedback circuit is provided whereby some of the rectified current is brought back to the input circuit of the amplifier. The writer has

shown<sup>1</sup> that by feeding back energy of reversed phase to the input of such a system, the rectifier characteristic can be straightened out and distortion considerably reduced. This principle of negative feedback, as was pointed out in the above reference, is also applicable to all sorts of electrical transmission systems such as telephone repeaters, power amplifiers, radio transmitters and receivers, where a number of advantages are obtained which have been well summarized by H. S. Black<sup>2</sup> and others. In the Model 300 voltmeter the application of feedback has the effect of straightening out the rectifier characteristic so that it resembles that of an ideal rectifier. As a result the output current can be made rigidly proportional to the a-c voltage applied to the input terminals of the amplifier. This method of securing a linear relation between rectified output and input voltage is superior (for voltmeter purposes) to the more usual method which relies upon the application of high voltages and/or the use of high series resistance. By making the resistance of the associated circuit small the automatic bias is reduced and the rectified current becomes more nearly proportional to the average value of an alternating current wave, whereas in the latter method it is proportional to the peak value. This is an advantage in that the effect of harmonics is reduced (depending of course upon their order and phase) and the readings become more nearly an indication of the true r.m.s. value of the fundamental, which is usually what we want to know.

#### Operating Principle

The principle of operation may be illustrated schematically by Fig. 4 which shows the application to a two-stage amplifier. The negative feedback path includes the insulating condenser  $C$ , the rectifier  $R$ , d-c meter  $M$ , and resistors  $R_2$  and  $R_1$ . The rectified current on one half of the cycle (plus that through  $R_2$ ) flows through  $R_1$  and introduces a negative voltage in the input circuit which opposes the applied voltage. On the other half of the cycle the rectifier current is zero (or small) and the current through  $R_1$  is that through branch circuit  $R_2M$ . As a result of this feedback the overall amplification is reduced and the

output current tends to become independent of the amplification and to depend mainly on the value of  $R_1$ . The stability is therefore very much improved because the effect of any factor tending to change the amplification—such as variation in line-voltage, tubes, circuit constants, etc.,—is reduced in proportion to the reduction in amplification. In addition the relation between d-c rectifier current and input voltage is made accurately linear in spite of the curvature of the particular rectifier employed.

The linearisation of the rectifier characteristic by the feedback may be very simply exhibited graphically. Let  $E_1$  represent the voltage between grid and cathode of the first tube,

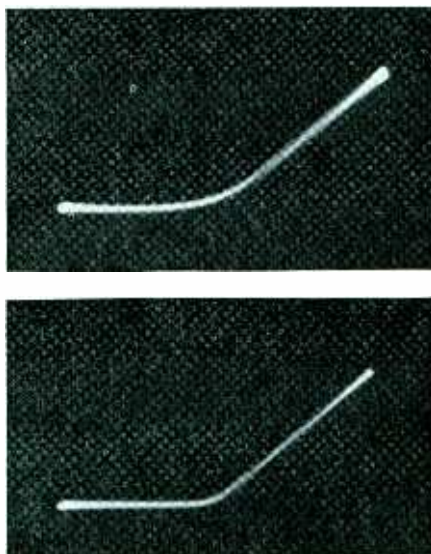

Fig. 2—Effect of feedback in straightening rectifier characteristic. Upper curve, without; lower curve, with feedback

$E_0$  the input voltage,  $I_2$  the current through the rectifier and  $R_1$  the coupling resistance. Let,

$$I_2 = f(E_1) \quad (1)$$

represent the  $E$ - $I$  characteristic of the amplifier and rectifier. Now,

$$E_1 = E_0 - R_1 I_2 \quad (2)$$

hence

$$I_2 = (E_0 - E_1)/R_1 \quad (3)$$

We are interested in the relation between  $E_0$  and  $I_2$  which can be found by solving (1) and (3) graphically. Plot (1) and (3) as shown in Fig. 3. The relation between  $I_2$  and  $E_0$  is then obtained from the intersections of the curves for various values of  $E_0$ . This relation is plotted in Fig.

3 which indicates the linearisation obtained under the assumed conditions—a square-law rectifier characteristic and feedback sufficient to reduce the gain about 10 to 1. It will be noticed that the action is analogous to that obtained by placing a large resistance in series with the rectifier, a well known expedient for securing linearisation. The equations are the same and the graphical construction is the familiar one for series resistance. This is consistent with the fact that constant current feedback raises the effective output resistance of the output tube. (In the foregoing we have purposely neglected the current through  $R_2$ ).

The linearisation effect of feedback

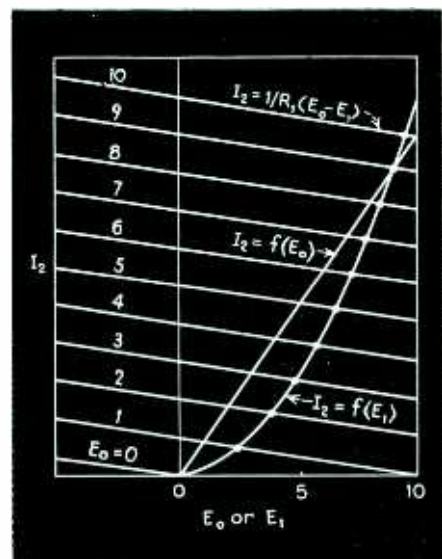

Fig. 3—Graphical construction showing linearisation of rectifier characteristic by negative feedback

is also shown by the oscillograms in Fig. 2. These show the relation between the rectifier current and the input voltage. The lower oscillogram was taken with feedback, while the upper one was taken without feedback and shows considerable curvature, which would produce a non-linear relationship between d-c output and input voltages, especially if the circuit constants were adjusted to indicate average rather than peak values.

The overall sensitivity of the arrangement as a volt-meter depends mainly on one resistance ( $R_1$ ) which can be constructed to have a high stability as regards both temperature variations and ageing. The applica-

<sup>1</sup>U. S. Patent 1,723,719 filed January 9, 1923.

<sup>2</sup>Bell System Technical Journal, Jan. 1934.



tion of preliminary amplification to electronic voltmeters has heretofore been unsuccessful because of instability, and inconvenient because of the resultant necessity of providing means for standardization at frequent intervals. Since the calibration of the voltmeter depends only on  $R_1$ , it can be adjusted once and for all with confidence in its future stability in spite of tube replacements and other variations.

Range switching is accomplished in the input circuit as shown in Fig. 4. In view of the wide frequency range covered ordinary high impedance resistance attenuators are useless and a combination resistance-capacity network is employed. (Not

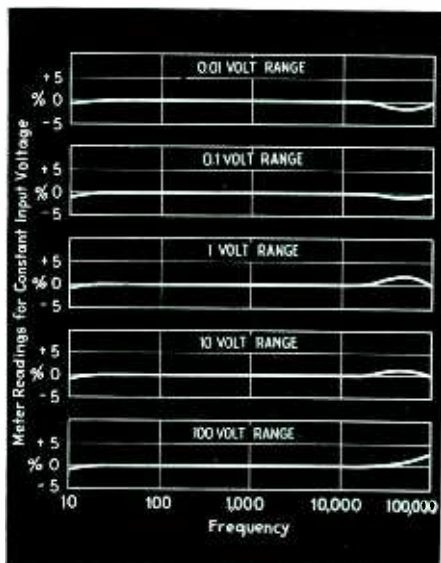

Fig. 5—Overall frequency characteristic of electronic voltmeter for the various ranges

shown in detail in Fig. 4). The input impedance is that of a 500,000 ohm resistance shunted by a  $25 \mu\text{mf}$  capacitance. One side of the input circuit is grounded. The accuracy which has been obtained in the attenuator and the "flatness" in the whole system are illustrated by the frequency characteristics of the several ranges shown in Fig. 5. In this diagram the ordinates represent meter readings for a constant input voltage of variable frequency.

#### Logarithmic Scale

One of the most important and novel features of the instrument is the logarithmic scale. As pointed out above, this extends from 1 to 10

and permits range switching in decade steps. Also a uniform percentage accuracy of reading is afforded over the entire scale. A photograph of the scale is shown in Fig. 6. A substantially uniform scale of decibels is also provided, printed in red and positioned below the voltage scale. This will be found useful in many applications.

#### Use as an Amplifier

In order to increase the usefulness of the instrument in the laboratory provision is made so that it can be used as an amplifier. An output jack is provided and by plugging in this jack the rectifier and meter are cut out of the circuit and a 20,000 ohm potentiometer is substituted. The gain of the amplifier is adjustable in steps of 10 (20 db) by means of the range switch and for finer adjustment the potentiometer knob (located just below the meter) may be used. The output impedance at full gain adjustment on the output potentiometer is a resistance of 20,000 ohms. The maximum voltage gain (output/input voltage) is 3100, or 70 db. The overall frequency characteristic as an amplifier is flat within 1 db to 100,000 cycles. The harmonic distortion on output voltages up to 30 volts is low. At this output voltage level the residual a-c hum is negligibly small, amounting to 0.05 volt or 0.2% (-56 db).

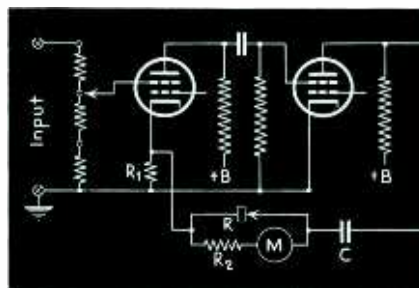

Fig. 4—Schematic diagram showing the application of negative feedback to two stage amplifier-rectifier system

In addition to its use as a wide-range voltmeter, the instrument can be used as an ammeter to measure a wide range of currents by connecting it across suitable resistances. Up to 100,000 cycles, resistance as high as 10,000 ohms may be connected in shunt with negligible error due to the shunting effect of the input ca-

capacity of the meter ( $25 \mu\text{mf}$ ). This would make a current of  $10^{-7}$  ampere (one-tenth microampere) measurable. To see what this unusual sensitivity means we may compare this performance with that of a conventional vacuum thermocouple. A standard 1000-ohm couple and meter combination requires a current of about 1 ma. for full-scale deflection. Possibly a current of one-fifth of this value, or 200 microamperes would be readable with accuracy. With the same 1000-ohm resistance shunt the electronic voltmeter would be capable of reading down to 1 microampere, an increase in sensitivity of 200 to 1.

#### Other Uses

A number of other uses for this instrument will readily suggest themselves to the engineer, among which the following may be mentioned:

(1) Frequency characteristic and gain measurements on amplifiers. The wide voltage range of the voltmeter makes it possible to read both input and output voltages. Voltage gains up to 100,000 (100 db) are measurable in this way.

(2) Transmission losses on telephone circuits, filters and other apparatus (including carrier systems up to 100 kc) by applying a known voltage at the sending end and using the voltmeter to read the level at the receiving end.

(3) Acoustic measurements; noise measurements and measurements of frequency characteristic of loudspeakers, public address systems and radio receivers, using a calibrated microphone connected to the input terminals.

(4) Vibration studies and geophysical measurements using a contact microphone connected to the input terminals. For these applications the uniform response at very low frequencies is of particular advantage.

(5) Bridge measurements, especially at low audio, high audio and supersonic frequencies where balance is difficult to detect aurally with telephones.

(6) Measurements in supersonic engineering.

(7) Servicing of public address and sound systems, photo-cells, amplifiers, loud speakers, etc.

(8) Maintenance of circuits and apparatus in radio broadcasting stations.

# TUBES AT WORK

Tank rectifiers in railroad service, eddy currents for roasting coffee, a "swinging-loop" ammeter, a C-R tube used for bridge indications, and an attenuator from a single resistor unit, all in this month's crop of tube and circuit information

## Mercury Rectifier Runs B. & O. Electric Train

TO MAKE ROOM for a street extension near the Howard Street Tunnel of the Baltimore & Ohio electrified line, in Baltimore, it was recently necessary to move a substation comprising two synchronous converters of a total capacity of 3000 kw., which supply power at 670 volts for the feeders within the Howard Street Tunnel. One available site, on

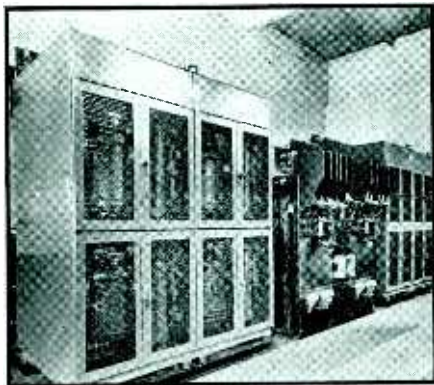

Rectifier installation replaces converter equipment

property owned by the railroad, was located but a few feet from the original location, but directly over the tunnel. It was feared that the vibration from the rotating converter units would weaken the tunnel walls if the substation were set up in this location. Consequently it was decided to retire the converters from active service and to replace them with mercury arc rectifiers.

The rectifier installation operates completely without vibration, and its foundation requirements are much less rigid than those of the rotating equipment. However, it is necessary that absolute freedom from interruption of service be attained. Consequently, two four-section rectifiers were used, each with sufficient overload capacity to carry the full load of two trains with a total of six electric locomotives. Each rectifier is rated at 3000 kw., with a 150 per cent overload capacity for two hours, or 300 per cent for five minutes.

The mercury rectifiers have shown an appreciable saving in power over the former converter equipment. Savings result primarily from the fact that the

no-load losses of the rectifier are approximately 35 kw. less than for the equivalent rotating converter capacity. In this particular railroad installation there are frequent periods when no upgrade trains are in the tunnel, and consequently the equipment is not loaded. However, a heavy overload may occur almost immediately when a train enters the tunnel section. The spare capacity of the rectifiers is available almost instantaneously, through the use of remote-controlled ignition switches. The rectifier system has been in use for two and a half months without failure or a single instance of "backfire." The same personnel that operated the converter equipment has been trained to take over the new duties associated with the rectifier installation.

• • •

## A Cathode-Ray Null Indicator

By E. B. McNULTY

GOOD SENSITIVITY together with ease of operation is desirable in every type of instrument but especially so in inductance and capacitance bridges which are necessarily cumbersome on account of the dual balance. In such circuits a visual indicator is of great advantage, because it will indicate the direction of the balance as well as the balance itself. The most common types of visual indicators in use today are the meter and

rectifier, the neon light, and the electric eye. The meter and rectifier are not recommended, because at the beginning of the balance there is great danger of harm to the meter, although it is suitable in all other respects. The neon light is of very little advantage over the phones, for it does not aid in finding the vicinity of the null point. The

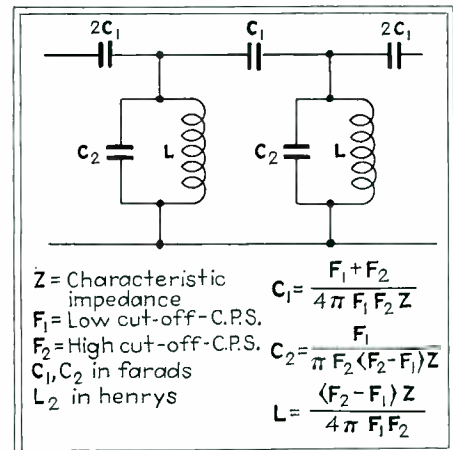

Design data for filter in null indicator

magic eye is good provided one uses a protective resistance in the grid circuit in order to prevent harm to the tube at the beginning of the balance. Greater ease and nicety of operation may be secured by the substitution of the 913 cathode ray tube in place of the magic eye. This change is quite inexpensive and well worth the slight additional cost.

It is quite simple to apply the cathode ray tube to the purpose at hand. A 60-cycle sweep circuit should be connected to the horizontal plates and the signal from the bridge should be coupled to the vertical plates. The null point is had when the vertical length of the pattern is smallest. The 60-cycle potential is applied to the horizontal plates as a precautionary measure against possible harm to the tube.

The 913 has a sensitivity of about 5 volts per millimeter, if operated at 300 volts anode potential. For most bridges

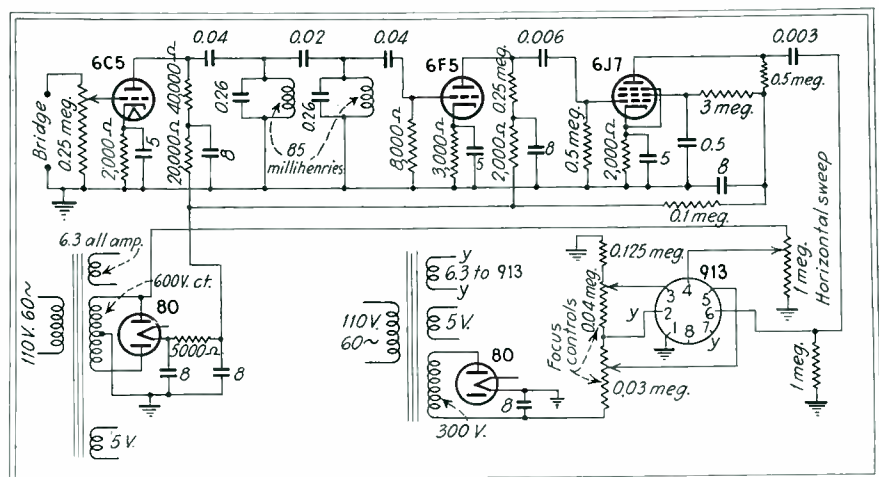

Complete circuit diagram of a bridge null indicator employing a cathode-ray tube





*All Metal*

# RHEOSTATS

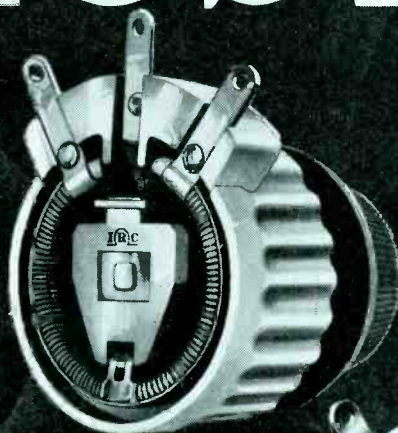

TYPE PR  
25 WATTS  
(ACTUAL SIZE)

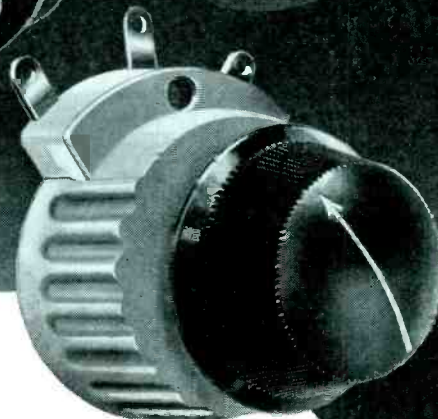

## DISSIPATE HEAT ALMOST TWICE AS FAST...

The 25 watts rating on the new IRC All Metal Rheostat means exactly what it implies: Use it anywhere up to its full rated load! Get more watts per dollar!

Temperature rise at full load is about half that of conventional rheostats, thanks to efficient utilization of the unique heat dissipating properties of aluminum. At full rotation and measured at the hottest spot, this rise is only 140° C. In addition, the full 25 watts may be applied across as little as one quarter of the winding area with only a minor temperature increase of 20° C.

The IRC All Metal Rheostat is no larger in size—costs no more. Another outstanding development by the world's leading makers of quality resistance products, it is your key to the utmost in rheostat efficiency, whatever the application.

Section VI of IRC Engineering Data on request—or send details of your application for our recommendation and sample unit.

## INTERNATIONAL RESISTANCE COMPANY

403 NORTH BROAD STREET, PHILADELPHIA, PA.

Factories or Licensees in Canada, England, France, Germany, Italy, Denmark and Australia

MAKERS OF RESISTANCE UNITS OF MORE TYPES, IN MORE SHAPES, FOR  
MORE APPLICATIONS THAN ANY OTHER MANUFACTURER IN THE WORLD



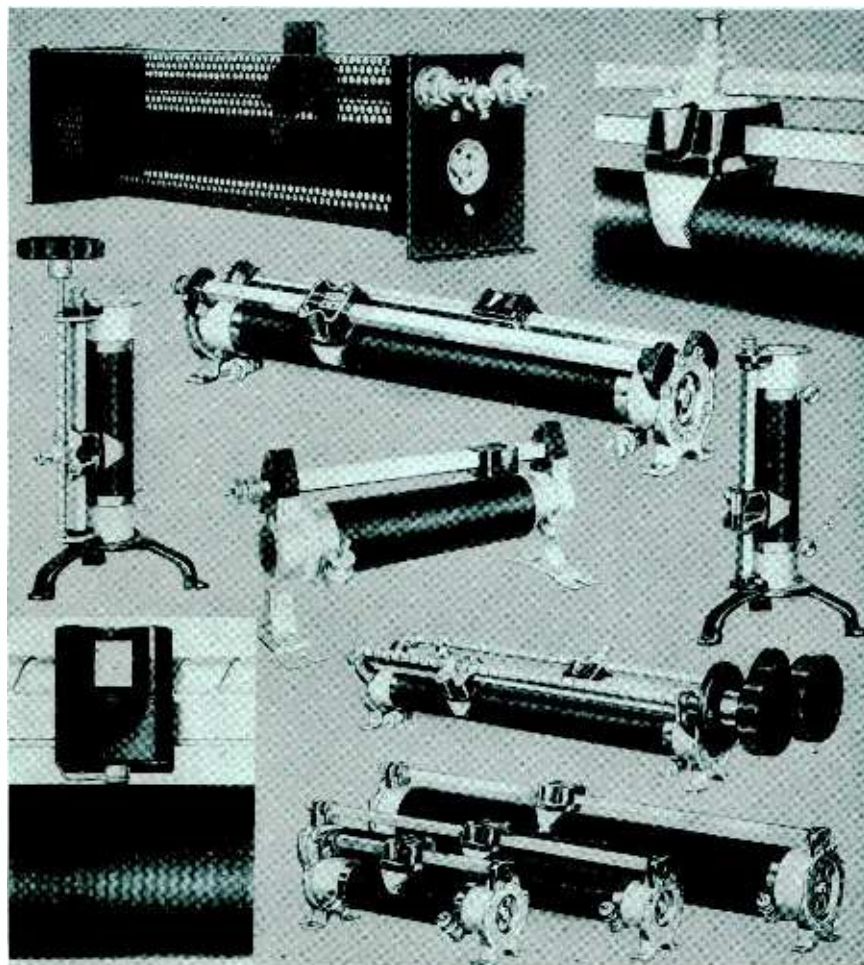

## SLIDING CONTACT RHEOSTATS EVERY TURN OF THE WIRE A STEP OF CONTROL

For Product Testing, Instrument Calibration, Laboratory Research and Development, for every operation that requires a fine continuous control of current and potential, you will find the Ward Leonard Sliding Contact Rheostat an ideal instrument. The sturdy construction makes them suitable for shop as well as for laboratory use. Various sizes and ranges are available for currents up to 25 amperes and voltages within their ratings, in vertical, horizontal and back-of-panel mountings, with or without micrometer drive. Send for Bulletin 8001.

# WARD LEONARD

RELAYS • RESISTORS • RHEOSTATS

Electric Control  devices since 1892

Ward Leonard Electric Company, 32 South Street, Mount Vernon, N. Y.

Please send me copy of Bulletin 8001.

Name.....  
Firm.....  
Address.....  
City..... State.....

a sensitivity of 0.1 of a millivolt is more than sufficient, and hence the total voltage gain for one millimeter deflection required is approximately 50,000. Under given circuit constants a 6J7 will give a gain of 350, a 6F5 a gain of 50, and a 6C5 a gain of 10. This set of tubes will afford us more than sufficient gain for the purpose.

It is a well recognized fact that the addition of an amplifier will increase the harmonic content. Since the oscilloscope, as used here, will not distinguish between the fundamental and harmonics, it is necessary to add a filter. The filter should be of the band-pass type and should be designed to pass all frequencies from approximately 950 to 1050 cps. without an appreciable diminution in gain. This will permit the use of an oscillator of but 5% stability. The type of band-pass filter together with its formulae are given in the accompanying figure.

It was found that the most suitable position for the filter was immediately after the plate of the 6C5. The necessary condensers and inductances to suit the characteristic impedance of the line at this point are commercially obtainable, and the loss in gain due to the filter is less than in any other position. In the calculations 933 cycles was used for frequency cut-off on the low side and 1067 cycles on the high side. These limits were used in order that the parts necessary for the filter could be obtained commercially. At first sight it may seem strange that the pentode follows the triodes, but since the filter

(Continued on page 42)

## EUROPEAN TUNING INDICATOR



One form of tube taken over almost bodily from American practice by European manufacturers is the tuning indicator eye. The base, similar to the octal base, has space for twelve pins



# Perhaps **TUBING** is just Tubing to you

But to us it's a career. That's all we make—fine small tubing in various metals and alloys. And with constant improvement in technical control and manufacturing economies we find ourselves each year in better position to cope with the widely diversified uses for our products. If your designs call for better tubing or a less expensive tubing we would appreciate your request for samples and quotations.

## **SUPERIOR TUBE COMPANY, NORRISTOWN, PA.**

MANUFACTURERS OF PURE NICKEL SEAMLESS CATHODE SLEEVES, AND  
ALSO PURE NICKEL LOCKSEAM CATHODE SLEEVES UNDER U. S. PATENTS

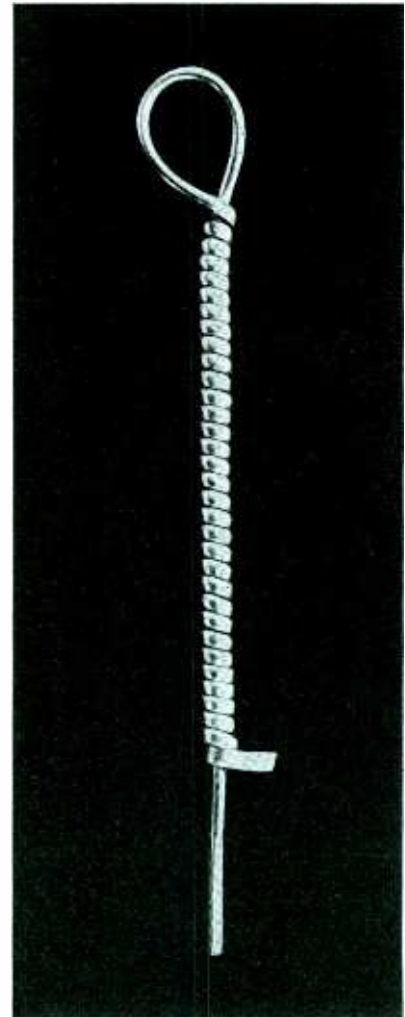

Formed by a patented process of Pressure Brazing and then cold drawn, BROWN Monel Tubing boasts practically all the advantages of Seamless at about two-thirds its price. Note from the above photo how this product successfully withstands sharp bends without fracture. . . . We produce also in Seamless—Nickel, Monel, and Inconel Tubing, as well as tubes in various Steels and Stainless Steels. . . . May we submit test samples to your specifications?

# SUPERIOR TUBING

# Announcing

## A NEW LINE OF SHIELDS TO FIT T-9 BULBS FOR BANTAM AND 50 MIL. 1.4 VOLT SERIES TUBES

This new series rounds out the Goat line of form-fitting tube shields, designed in close cooperation with the country's leading tube engineers, they will give you maximum efficiency in the purposes they serve.

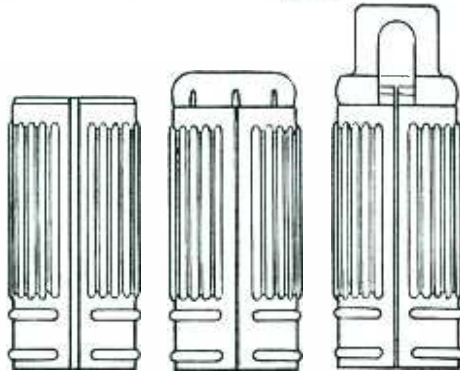

### Features:

- Sturdy construction
- Convenient grounding
- Complete shielding
- Modern appearance
- Easy assembly
- Space saving
- Economy



### The Improved 1100 Series of Goat Form-Fitting Tube Shield

This series remains the standard for every type of radio receiver: Auto, Battery, AC-DC, A.C. Phono-Combination receivers, etc., etc. You will find Goat Tube Shields as regular equipment on a majority of all manufactured sets . . . a splendid testimonial to their quality and design.

### For the Industry

We are equipped to render a complete shielding service to the radio industry. Our plant is fully equipped for drawing, stamping and forming every kind of radio metal part. Ask our engineers to help you work out your special problem. You can count upon quality merchandise and workmanship . . . with maximum economy and service. We will be pleased to send Bulletins, samples and prices to recognized manufacturers.



**GOAT RADIO TUBE PARTS, INC.**

[A DIVISION OF THE FRED GOAT CO., EST. 1893]

314 DEAN ST., BROOKLYN, N. Y.

should be placed towards the beginning of the amplifier in order to allow greater gain to be used without any special precaution against oscillations and stray pick-up, this order was selected and it works out quite well.

The filter must be adjusted closely in order that good results may be obtained. This can be done by the aid of a beat-frequency oscillator or a good inductance and capacitance bridge. The former is the better method. The coils and condensers should be lined up in much the same way as I.F. transformers.

There are only a few constructional precautions. The entire filter should be shielded and it is well to shield each inductance from the other. One system is to mount the band-pass arrangement in a transformer case and to insert a metal plate between the chokes. The leads from the 6F5 to the 6J7 should, of course, be shielded. Arrangement should be made to couple the amplifier to the bridge with the least possible capacity effect. This can be done by connecting the ground terminal of the bridge to the ground of the amplifier, and by connecting the remaining terminal of the bridge to the grid of the first tube in the amplifier through the gain control. The capacity across the bridge will be only that of the tube which is very small, about 4.5 mmf. A good external ground should be connected to the ground terminal of the bridge. The whole assembly can be housed in a metal shield about 10 x 8 x 8 inches. One transformer may be used instead of the two given in the diagram.

The band-pass filter can be made to pass any other band of frequencies by the application of the formulae given in the diagram.

To put the null indicator into operation it is only necessary to adjust the focus controls of the oscilloscope until

### CYCLOTRON BEAM

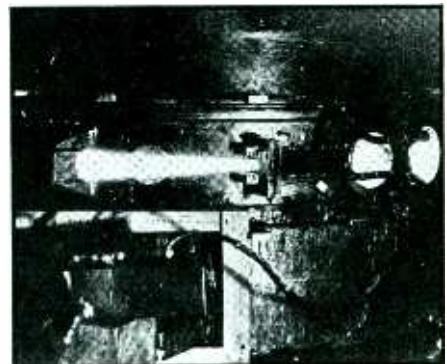

The beam shown in this photo is caused by the impact of high speed particles on the air as they emerge from the exit window of the cyclotron at the University of California. The beam, nearly a foot long, is produced by particles whose energy is about 6,000,000 electron volts. Ordinarily the beam is used to bombard materials placed just within the exit window



LESS THAN  $7\frac{1}{2}\%$  OF THE  
COST OF YOUR NEW  
RADIATOR  
WILL BE FOR

*Insulation*

## GIVE IT THE SECURITY OF INSULATION BY LAPP

If you are planning a 400-foot antenna structure, a self-supporting radiator will probably be recommended. The erected cost of the structure will approximate \$8,600. Insulation with four Lapp push-pull units will cost \$640, less than  $7\frac{1}{2}\%$  of the total investment. In a guyed radiator the ratio of base insulator-to-structure cost will be substantially less.

And if you are planning such a structure, it is because you expect to

achieve finer transmission quality. Is it not a wise investment, then, to give your radiator the security of insulation by Lapp? For then, and only then, would you have the assurance of complete electrical insulation, whatever your transmission equipment, whatever your antenna feeding circuit.

Ask for Lapp Bulletin No. 137. It tells the story of Lapp tower footing and guy insulators and porcelain water coils.

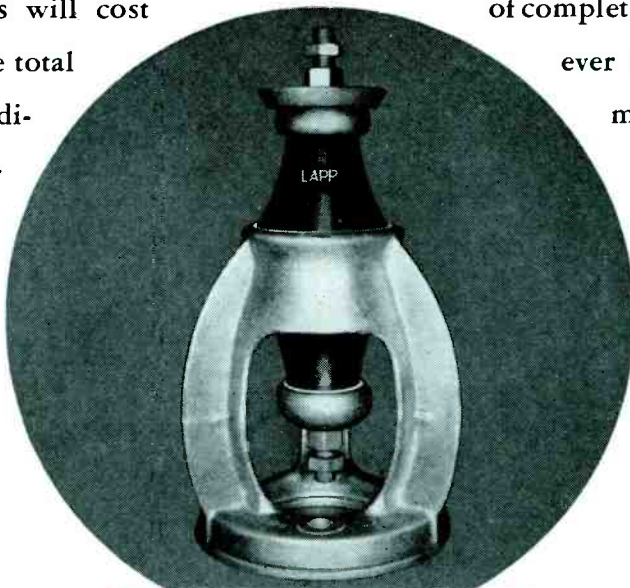

**LAPP**  
**INSULATORS**

LAPP INSULATOR CO. INC.

LE ROY - N.Y. - U.S.A.

# Indispensable . . . FOR AUTOMATIC TUNING

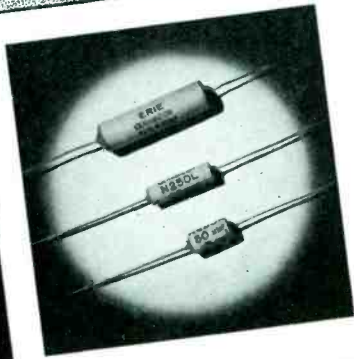

## ERIE CERAMICONS

with a  
Definite, Linear  
and Reproducible  
Temperature Coefficient

These silver-ceramic condensers can be supplied having any temperature coefficient between  $+0.00012$  and  $-0.00068$  mmf/mm $^{\circ}$ C. Any reactance change in the tuned oscillator circuit between  $+0.012\%$  per  $^{\circ}$ C and  $-0.068\%$  per  $^{\circ}$ C due to variation in temperature can be compensated for by using the proper Ceramicon as part or all of the capacitive reactance. Their operation is unaffected by changes in frequency and humidity. Single units are made up to 1,000 mmf with the highest negative temperature coefficient, and up to 250 mmf with zero temperature coefficient.

The Erie engineering department is at your service for helping you find the best and most economical method of obtaining tuning stability.

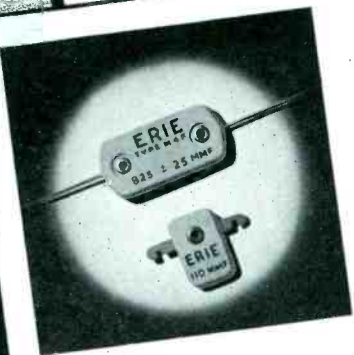

## ERIE SILVER MICA CONDENSERS

with  
Practically Zero  
Temperature Coefficient

These small condensers consist of pure silver plates in intimate contact with mica dielectric. As their temperature coefficient of capacity is only  $+0.000025$  mmf/mm $^{\circ}$ C (small size, Type A,  $+0.00004$  mmf/mm $^{\circ}$ C) they insure tuning stability when used in place of ordinary mica condensers in the high frequency oscillator circuits. Erie Silver Mica Condensers have a power factor of less than .04% and are sealed in low loss ceramic cases with special wax as a protection against humidity.

Because close control of the capacity can be maintained throughout the manufacturing process, tolerances as small as  $\pm 1\%$  can be obtained without making costs prohibitive. Made in capacities of 15 to 2500 mmf.

**ERIE RESISTOR CORPORATION, Erie, Pa.**

TORONTO, CANADA • LONDON, ENGLAND • PARIS, FRANCE - J.E. CANETTI CO.

RESISTORS • SUPPRESSORS • CONDENSERS • INJECTION MOLDED PLASTICS

vacuum tube relay, actuates one pen of a two-pen chronograph. The other pen of the chronograph is controlled by a time standard, such as a 1000-cycle clock, calibrated to whatever degree of accuracy is necessary. The tape from the chronograph is then examined to give the period of the oscillating ring, from which the high frequency current in the exciter ring can be computed directly, or obtained from a calibration chart. The impedance of the instrument is extremely low, much lower than that available from other high frequency ammeters.

• • •

### Eddy-Current Oven Roasts Coffee

ACCORDING to information received from Samuel Wein, the Uni-roast Co., of New York, have demonstrated a new method of roasting coffee, by the use of a high frequency current generated by a thyatron inverter circuit. Ordinarily the coffee bean is subjected to heat from the outside layers, where the large exposed area permits many of the essential oils to be lost before the bean is roasted through. The eddy-current system on the other hand affects all portions of the bean simultaneously, and as a result the roasting process is completed in a shorter time. The machine for roasting the coffee handles two pounds at a time, supplied from a hopper having a 50-lb. capacity.

### SUB-SURFACE LOUD- SPEAKER

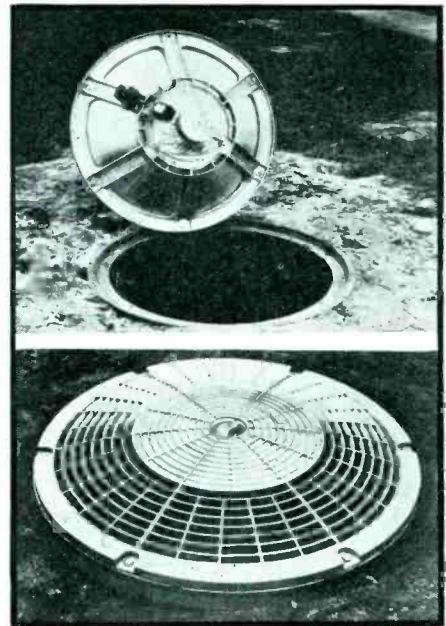

At the recent gymnastic festival at Breslau, commands to the participants were carried through loudspeakers mounted in the surface of the ground and covered by a protective metal grill



# NEW LENZ SHIELDED AUTO RADIO LEAD-IN

**KNOCKS CAPACITY  
TO A NEW LOW!**

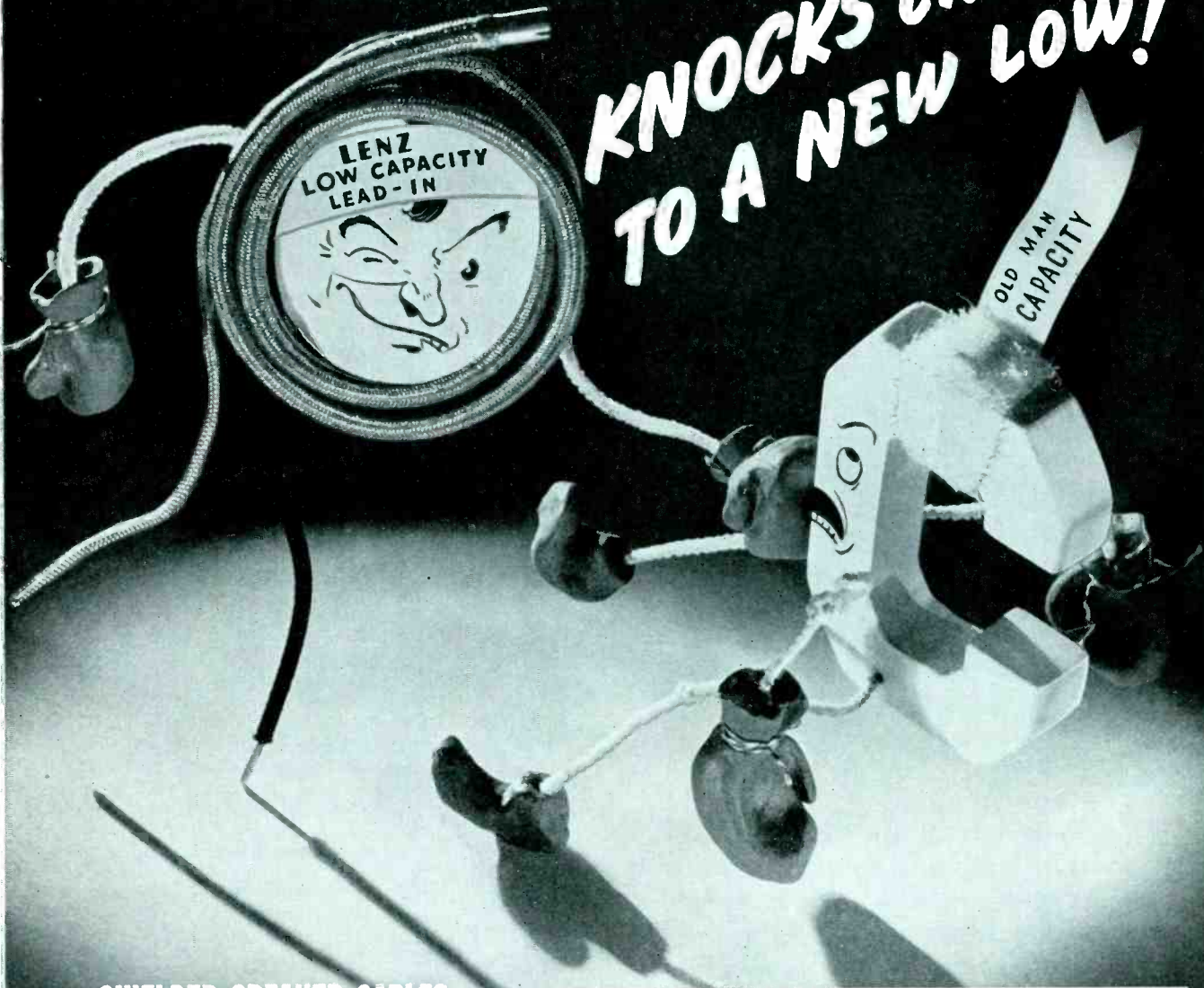

SHIELDED SPEAKER CABLES  
SHIELDED BATTERY CABLES  
CHASSIS HOOK-UP WIRE  
COPPER BONDING BRAID

- ★ Mistracking reduced due to minimum capacity
- ★ Higher Antenna Gain
- ★ Better Signal-to-Noise Ratio
- ★ Excellent Mechanical Properties



"In Business Since 1904"

**LENZ ELECTRIC  
MANUFACTURING CO.**

1751 NORTH WESTERN AVE., CHICAGO, ILL.

LENZ ELECTRIC MANUFACTURING CO.  
1751 No. Western Ave., Chicago

Gentlemen: Please send me FREE  
.....ft. sample of Lenz Shielded  
Low Capacity Auto Radio Lead-in.

Name .....

Position .....

Company .....

Address .....



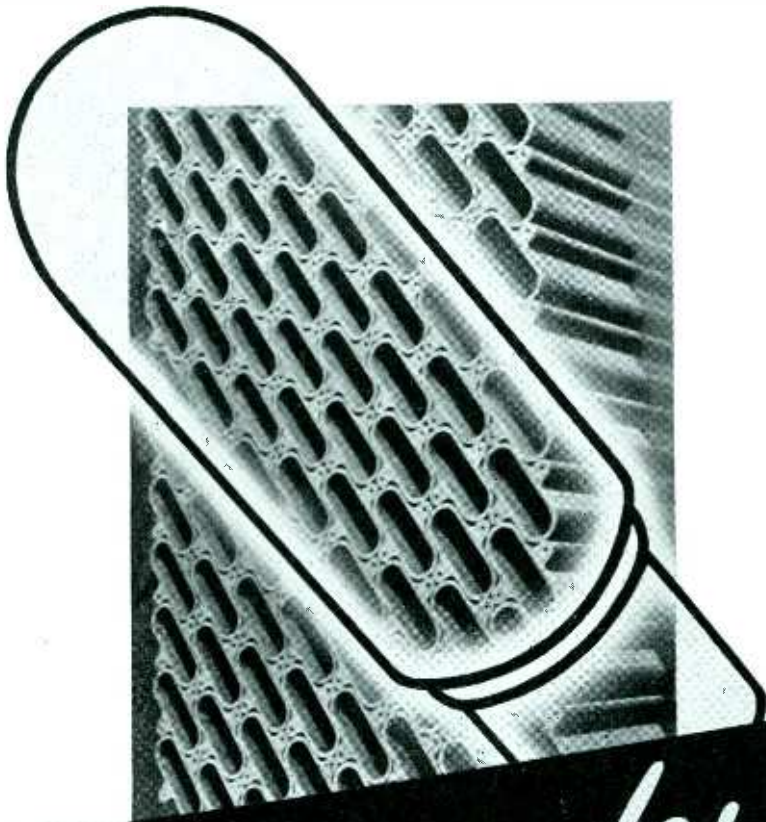

*The anodes  
make the tube*

Unless your transmitting tubes have SPEER Graphite Anodes, nothing else can make up for what you lose. Of all anode materials, only Graphite cannot melt, cannot even soften or warp, no matter how high the temperature. No other anode material even approaches Graphite in heat dissipation, radiation emissivity and thermal conductivity. Only SPEER Graphite Anodes bring you these advantages to the maximum extent. Their use by leading manufacturers insures better, more uniform tubes with greater power and longer life. SPEER Graphite Anodes are sold only to the tube manufacturers. Write for list and Anode Booklet No. 70.

# SPEER CARBON CO.

ST. MARYS  PENNA.

NEW YORK CHICAGO MILWAUKEE DETROIT PITTSBURGH CLEVELAND

Ⓢ 8368

## A Simple-Constructed Attenuation Network

By FRANCIS KING, WJTN

IN MOST attenuator problems, the "T" type of pad fills the bill. In such a pad three separate resistors are connected in such a manner as to give the proper matching load to both impedances, between which it is connected, and the desired amount of loss for the particular purpose at hand. This is shown in Fig. 1.

By making a simple change in the legs of the network, which is merely one of arrangement, we take one of the legs of the "T" pad and move it to the opposite end of the parallel leg. This arrangement, called a "Z" pad from its schematic appearance, is shown in Fig. 2.

Since in the "Z" pad all resistances are in effect in series, it is obvious that

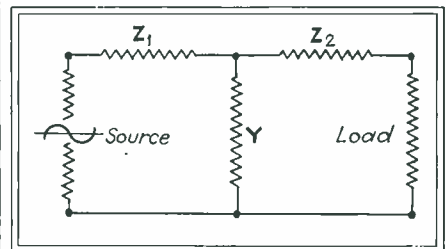

Fig. 1—Conventional "T" attenuator

a single resistor unit may be used. Figure 3 is a sketch showing the proper terminals for both input and output connections, and the sections are marked so that comparison may be made with other types of pads. For pads having both input and output impedances the same, a single 1500-ohm resistor will cover all attenuations between 4 and 48 db and from 50 to 600 ohms in and out.

For example, consider an attenuation network to be inserted in a 500 ohm line

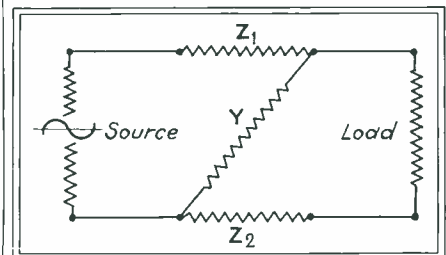

Fig. 2—"Z" pad equivalent to that in Fig. 1

with a loss of 18 decibels. From any of the several charts available we find that a "T" pad has sections  $Z_1$ ,  $Y$  and  $Z_2$  of 388, 128 and 388 ohms each respectively. Thus with an ohmmeter we measure the first section from A to B in Fig. 3 and set the first clip at the point of 388 ohms. From this point B we measure to point C for the Y or parallel section and adjust this clip to 128 ohms. Again, from this point, we measure to D for 388 ohms and set the last clip. The total resistance necessary is, then, 804 ohms.

Assuming another case, in which we wished to match 3000 ohms to 500 ohms and wished to attenuate the signal 15



# You can get it NOW!

Western Electric's new 5 KW  
—with the Doherty Circuit—is ready  
for immediate delivery

Improve your service to clients and listeners  
with this pace-setting transmitter!

## ASK YOUR ENGINEER about these outstanding features:

Doherty Circuit increases power amplifier efficiency more than 100%, from the usual 30% to over 60%, requiring less primary power and greatly reducing operating costs . . . improved stabilized feed-back circuit . . . engineered to permit increase to 10KW, 50K W or 500K W by adding standardized apparatus.

*For detail, write the Distributor: Graybar Electric Co., Graybar Building, New York. In Canada and Newfoundland: Northern Electric Co., Ltd. In other countries: International Standard Electric Corp.*

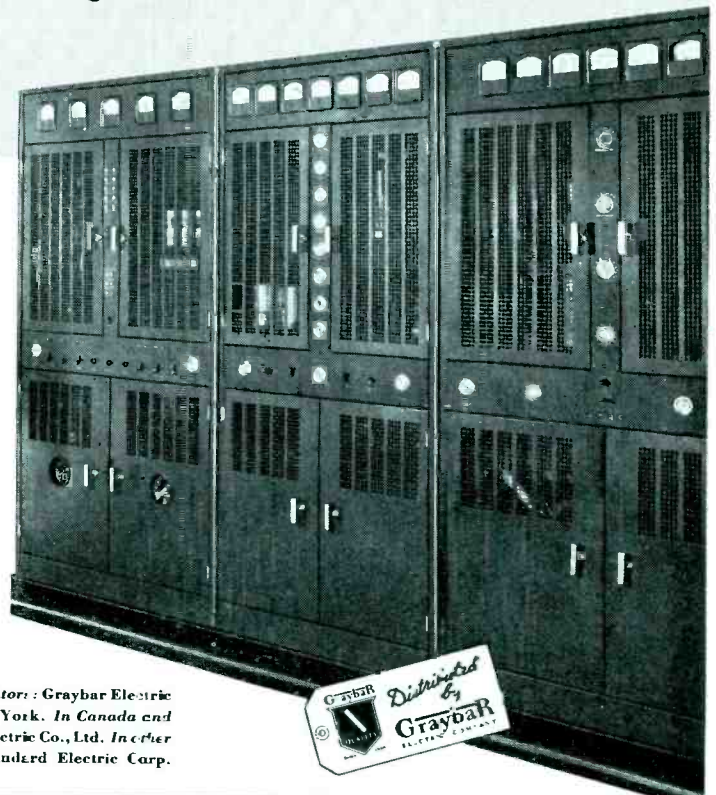

## Western Electric

RADIO TELEPHONE BROADCASTING EQUIPMENT

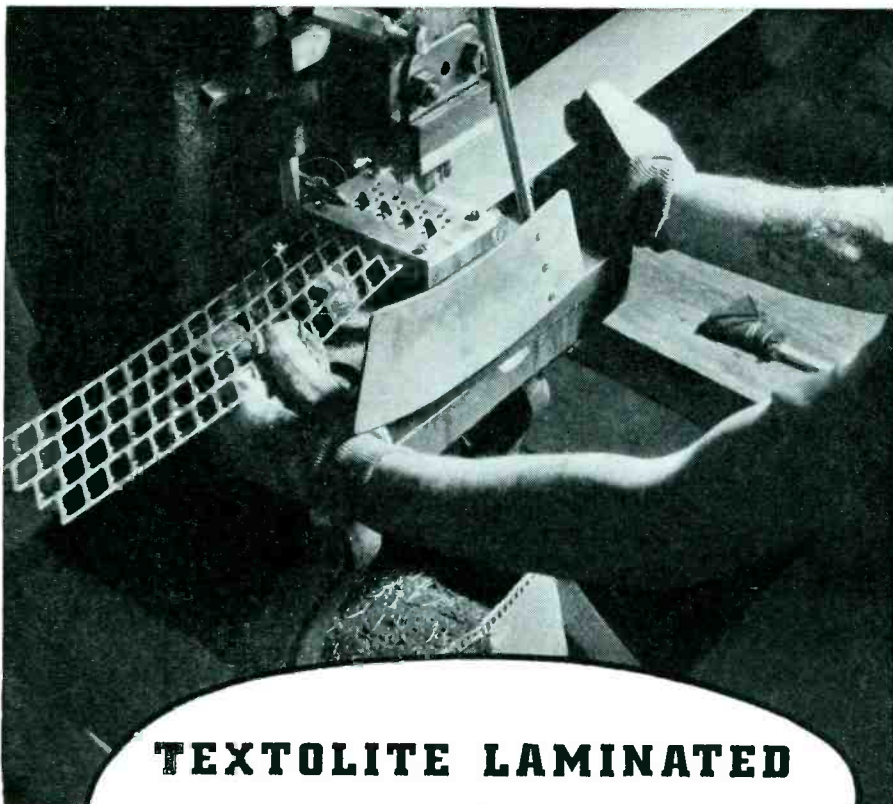

**TEXTOLITE LAMINATED**  
**AND THE *A.S.T.M.***



**T**HE American Society of Testing Materials has recommended four grades of paper-base laminated insulation for use in electronic applications. These four grades are usually fabricated by punching.

Number 1 (G-E grade No. 2047) is suitable for noncritical insulation and is easily punched, even in the most intricate shapes.

Numbers 2 and 3 (G-E grades No. 2008 and 2051, respectively) have excellent electrical properties and can be punched in intricate shapes with the most advanced punching technique.

Number 4 (G-E grade No. 2029) is punched with so much difficulty that it is limited, more or less, to simple-shaped punchings but has the highest possible electrical properties.

The fabricated parts illustrated are for critical purchasers whose requirements are exacting both as to properties and fine workmanship. These

purchasers rely on G-E Textolite and on General Laminated's\* ability to design fine punching dies and to fabricate their parts accurately.

For complete information and samples of the above punching grades of Textolite laminated write to General Laminated Products, Inc., or to Section A-3, Plastics Department, General Electric Co., Pittsfield, Mass.

**GENERAL LAMINATED PRODUCTS, INCORPORATED**  
 233 Spring St., New York, N. Y.      3113-3123 Carroll Ave., Chicago, Ill.

\*G-E Textolite Distributor and Fabricator



decibels, from available charts or formulae we find that  $Z_1 = 2745$  ohms,  $Y = 449.9$  ohms and  $Z_2 = 83$  ohms. For a

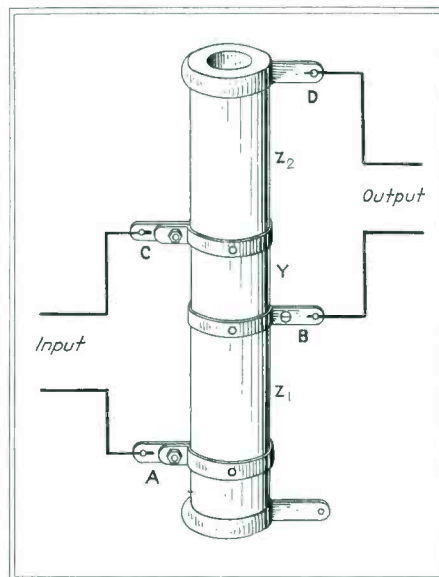
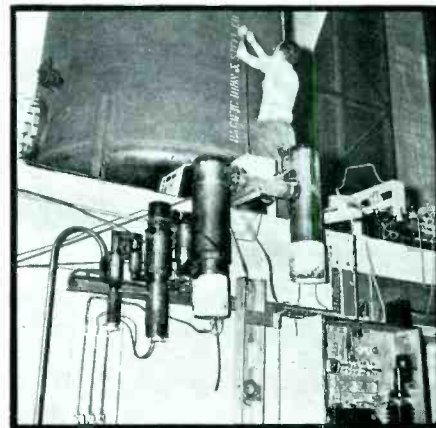

Fig. 3—Arrangement of clips in "Z" pad

"Z" pad we would measure the first section on the resistor between terminals A and B and set at the value 2745 ohms. Next section Y between terminals B and C is made 450 ohms. Finally section  $Z_2$  between terminals C and D is given the value of 83 ohms, completing the network. In this case, as well as in the case of the 500 ohm pad, the input will be terminals A and C and the output will be terminals B and D. The total series resistance is 3278 ohms. A resistor having a total of 3500 ohms would be satisfactory for the purpose.

**TWO-MILLION VOLT  
 GENERATOR AT CALTECH**



A modified form of Vandergraff generator, capable of developing two million volts, is now being installed at Caltech for use in atomic disintegration and X-ray research. Transmutation of the heavier elements and experimentation with X-rays of very high penetrating power are part of the intended program



**LONGER LIFE** and

**GREATER DEPENDABILITY WITH CORNELL-DUBILIER CAPACITORS**



**TYPE TJU** Fireproof Dykanol Transmitting Capacitors. Dykanol (chlorinated diphenyl) impregnated and filled and hermetically sealed in sturdy steel containers. Supplied with adequate glazed porcelain or bakelite terminal (according to rating) insulators and universal mounting strap. Rigidly tested and conservatively rated.

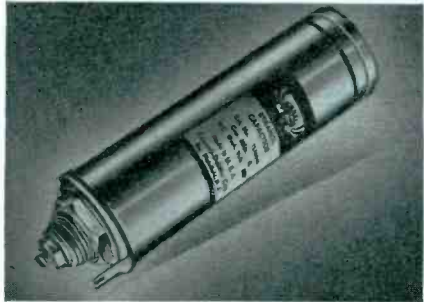

**TYPE TLA** Dykanol Filter Capacitors. Encased in cylindrical aluminum containers these capacitors are used with high fidelity P.A. amplifiers, power supplies for S.W. portable transmitters and transceivers. Substantially made the Type TLA will withstand transient voltages as well as high peak voltage surges.



**TYPE DY** Dykanol Capacitors. Designed for operation under severe tropical and humidity conditions. These capacitors are required to stand a test that calls for immersion in boiling water. Extensively used by manufacturers of aircraft, submarine and marine equipment. Available in single, dual and multiple capacity combinations.



**TYPE BR** "Blue Beavers." The Type BR etched foil dry electrolytics are hermetically sealed, vented and encased in round aluminum containers with a protective outside sleeving. These capacitors eliminate drilling of chassis, use of pal nuts, washers and minimize assembly operations as well as save space and afford quick wiring.

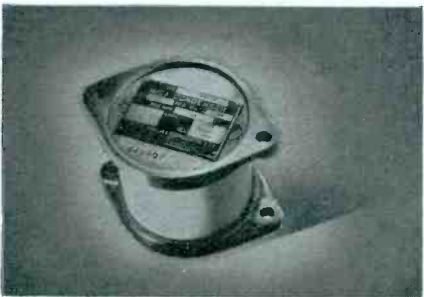

**TYPE 59** Mica Transmitting Capacitors. Encased in a ceramic tube with cast aluminum end terminals. Series, series-parallel or any other combination, can be obtained by bolting terminal ends together. These capacitors are used as neutralizers, padders, in tank circuits and wherever low capacity at high voltages is required.



**TYPES 9 AND 4** Mica Receiving-Transmitting Capacitors. Effectively used for R. F. bypass, high voltage D.C. blocking, low power tank capacitors, padders, coupling functions, audio and video purposes. Utilizing the exclusive C-D stack assembly process, these units are constructed of the finest India ruby mica and foil.



**TYPES 6 AND 15** Mica Transmitting Capacitors. Designed to fulfill needs of low power transmitters, S.W. and portable equipment. These units are hermetically sealed in molded bakelite cases. Type 15 is enclosed in low loss mica base bakelite case. Low absorption value of case allows operation of units at high humidities.

MICA - PAPER - DYKANOL

**CORNELL-DUBILIER**  
ELECTRIC CORPORATION  
South Plainfield, New Jersey  
Cable Address: CORDU

WET & DRY ELECTROLYTIC

**MAIL COUPON FOR NEW FREE CATALOG** E9

**CORNELL - DUBILIER ELECTRIC CORP.**  
1006 HAMILTON BOULEVARD, SO. PLAINFIELD, N. J.

Push to me copy of Catalog 160   
Put my name on list for house organ

Name.....

Address.....

City..... State.....

# D-C Voltmeter with Degeneration

(Continued from page 17)

way of binding post bushing, special impregnation of the selector switch and other mounting elements in the input circuits, to prevent leakage errors across the grid circuit due to very high humidities.

## Applications

Some of the more common applications to which this instrument is particularly suited are as follows: Measurement of ion and weak electron currents in various thermionic tube circuits; secondary emission currents; leakage currents between tube elements and between circuit elements; potentials and currents in AVC and AFC circuits; general insulation tests, particularly where the use of low voltage is desirable; weak electron-beam currents in cathode ray and special tubes for television purposes; minute currents in phototubes as used in densitometers, control circuits, etc.; electrolysis and corrosion currents and potentials; and galvanic currents and potentials in biological research.

## BIBLIOGRAPHY

An Improved Vacuum Tube Microammeter by A. W. Vance, *Review of Scientific Instruments*, Dec. 1936, pages 489-93.  
An Ultra Sensitive D-C Meter by J. M. Brumbaugh, *Broadcast News*, Dec. 1937, page 16.  
New Amplified D-C Meter, *Radiocraft*, April 1938.

# An Electronic Consultant

(Continued from page 12)

cial trip to learn how well their engineering department functioned. At the end of the discourse I suggested that I might possibly be of use at some future time if they had something they couldn't do or felt like it was too simple for them to fool with. I walked down the four flights of stairs and I caught a train home.

There is a sequel, however. Later on, business had dwindled in the

gauging line so I sent out a circular letter to names got out of a trade register. One of the letters went to Punky Sink and I got another call from them. After the 600-mile train ride, this time I got in to see the engineer in about 20 minutes and found a new face. A pleasant sort of a chap and with him were two confederates. All of the gentlemen were armed with high speed centrifugal information pumps. It seemed like they had just designed a trick assembly and were manufacturing it but unfortunately they admitted that their gauging method was not so hot. Would I please tell them how to gauge this assembly? No, I would not tell them how to gauge the assembly but would sell them an automatic gauge that I would guarantee to do the job at the rate of one hundred a minute. The gauge was discussed at length when one of the bright boys spoke up and said they don't want me to build

an automatic gauge for their use. They could do it themselves. What they wanted to know was how to do it. I said sure I would tell them how and when could I start in? He said right now. I asked about an order to cover the engineering fee and when I gave him a very nominal figure for the job he nearly fainted.

He said, "you see we can't pay you to do that; we have engineers for that purpose."

One of my most happy experiences, however, has been with a large New England concern making an enormous quantity of little gadgets. It took me two years to sell them since they were (as they called themselves) "hard headed Yankees." They never pumped me but gave me every help for the month I was in their factory. The chief engineer was a farmer-type of fellow who liked to tell stories but a gentleman from the word go and the smartest mechanical engineer I have ever met. This outfit is sorting over a million gadgets a day on my machine and are happy over the whole set-up. Incidentally they are saving money. I might venture to say that ten times the cost of the machines would not buy them if they could not be replaced.

My experience with Punky Sink has been repeated several times with others, but I always keep coming back hoping that the next call will lead to a job and sometimes it does.

## Decide Whether to Take Credit or Cash

For example the High Class Mfg. Co. made a small part that went into a radio set. I had built testing machines for this part and sold a number of them. They did not cost much to build but saved the manufacturers of small parts a lot of money, and I sold them at a good profit. Nearly everybody that bought one was pleased with the machine but some objected to paying for it, after they saw it, because it was so simple. Even though they could pay for it out of 60 days' savings, they felt my price was unreasonable.

One of these companies had an engineer who had written monographs on how they tested these small parts and stated that his concern had an automatic machine based on his principles. After reading his printed stories I surmised that they might be having difficulty with his circuit and dropped them a note. Eventually I sold them two units. The engineer got the credit and I got the business.

## TWO NEW STATION SELECTORS

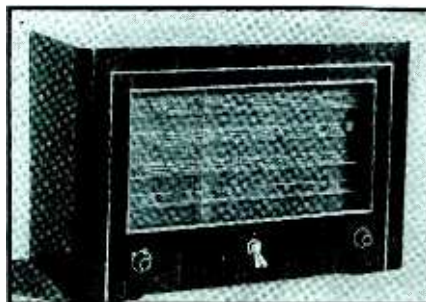

This tuning indicator consists of glass imprinted with calls and locations, on four separate bands. Side lighting illuminates only the markings for the band then in use

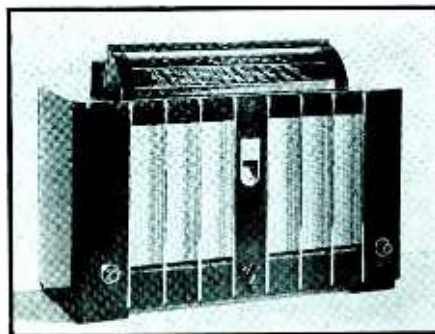

The latest sets released in Germany reveal unusual tuning arrangements. Above is the "retractable" type featured by Telefunken. The station indicator folds down into the cabinet when not in use



# Announcing!

the greatest  
SINGLE  
IMPROVEMENT  
in the history of  
instantaneous re-  
cording equipment



PRESTO 6-D RECORDING TURNTABLE EQUIPPED WITH  
AUTOMATIC EQUALIZER

## THE NEW PRESTO AUTOMATIC RECORDING EQUALIZER \*

It does a job no human skill can duplicate. It compensates smoothly and accurately for the progressive attenuation of high frequencies on 33-1/3 rpm recordings and as it varies the equalization it keeps the output of the recording amplifier at a constant level. It makes the quality of your 15-minute recordings the same from beginning to end . . . no hollow, tubby quality near the center of the record due to loss of highs . . . no shrill rasping reproduction at the outside due to over-equalization. And it's completely automatic in operation . . . requires no attention from the operator during recording.

This new device can be installed on your Presto recorder in less than ten minutes. Simply loosen two screws and clamp the slider unit onto the over head feed mechanism.

Plug the cables into the control box, connect to the 500 ohm input of your recording amplifier and your equipment is ready to make the finest instantaneous recordings you ever heard.

Price of Presto automatic recording equalizer complete \$156.00 net to broadcasting stations. (F.O.B. New York)

\*Patents pending.

**Place Your Order Today and  
be Certain of Prompt Delivery.**

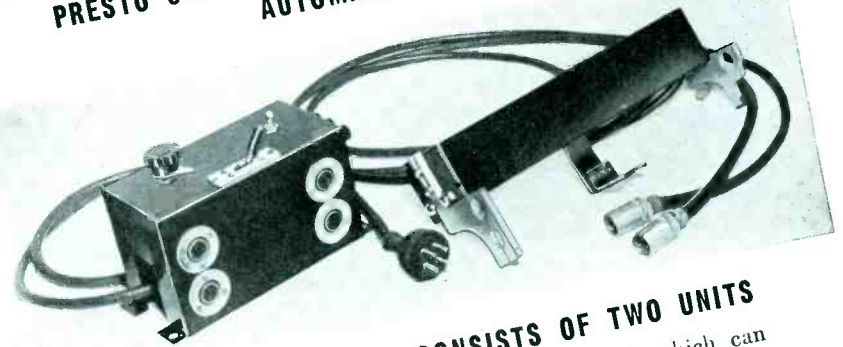

### THE NEW EQUALIZER CONSISTS OF TWO UNITS

1. A control box containing the tuned circuit which can be adjusted to peak at either 6000 or 8000 cycles, receptacles for the cables from two slider units, a cable connecting to the amplifier input and a changeover switch to connect the unit to either of two turntables.
2. A slider type, variable resistance network which engages with the cutting head mounting and moves across the surface of the disc with the cutting head. One resistor adjusts the slope of the amplifier curve to compensate for the changing groove radius. The second, a T pad, controls the amplifier gain in steps of 1/4 db. to compensate for the insertion loss of the equalizer.

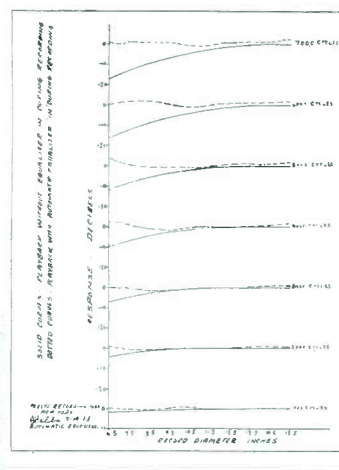

Solid curves show the losses of high frequencies for various groove radii. Dotted lines show the correction made by the Presto Automatic Frequency Equalizer. Note that throughout the portion of the record used in making 15 minute transcriptions, the frequency response is uniform within 2 db. up to 7,000 cycles. Without equalization the loss at a groove radius of 3 1/2" is 15 db. at 7,000 cycles and over 8 db. at 4,000 cycles. The Presto 1-B high fidelity cutting head was used in making the records for measurement.

**PRESTO** RECORDING  
CORPORATION  
147 W. 19th ST.

# THE ELECTRON ART

Each month the world's technical literature is scanned to see what physicists and engineers are doing with tubes, for presentation in tabloid form to Electronics' readers

## New Metal for Grids

By R. K. KENNEDY

Kemet Laboratories Co., New York

THE IDEAL METAL for receiving tube grids must possess great stiffness, a great tensile strength, and a high surface work function, and it must retain these properties even at temperatures up to 700 or 800 deg. C. Its surface conditions must be such, chemically, as to remain practically unaffected even after receiving a condensate of metals or oxides when the getter is flashed or from the distillation of oxide-coated cathode surface materials. This is necessary to assure a minimum of grid emission.

In addition to these characteristics, it is necessary that the wire, when formed on a mandrel, should produce grids of uniform dimensions. Experimental work, carried out recently in the laboratory and confirmed by production tests in radio tube factories, has shown that such wire must come within a narrow range of tensile strength. In the case of one nickel-molybdenum-iron alloy, Hastelloy A (Moly Alloy), this range lies between the limits of 130,000 and 140,000 lb. per sq. in., and for a relatively new alloy of similar composition but containing more molybdenum, known as Hastelloy B (Moly Alloy Type HB) it is between 150,000 and 160,000 lb. per sq. in. Although the tensile strength is a dependable index of performance in the grid-making operation, the elastic limit or yield point is probably the governing factor.

While it is true that the present-day choice of materials represents the optimum balance of the qualities most required in a particular tube design, the physical properties of the more recently introduced alloy promise to alleviate the situation considerably. Up to now, materials for No. 1 or control grids—those usually operating under the most exacting conditions—have included molybdenum, Hastelloy alloy A (Moly Alloy) and chromium-nickel alloys. This is the order of their stiffness, but the inverse order of their resistance to the effect of contamination and the resultant increase in emissivity caused by deposited oxides.

Under less stringent operating conditions, such as exist at grids further from the cathode or at their support rods, other materials have been found

satisfactory. Several of the heavy metals are very stiff even at elevated temperatures, but unfortunately in many cases, when used for control grids, they may emit electrons, thereby altering the tube characteristics and causing undesirable distortion.

The presence of molybdenum in Hastelloy A (Moly Alloy) imparts to this alloy a high degree of stiffness which is retained even at considerably elevated temperatures. However, the new alloy, Hastelloy B (Moly Alloy Type HB), which contains a larger amount of molybdenum, possesses even greater stiffness. While an exact evaluation of the property of stiffness is not given by the usual physical tests, the short-

## SUPER ELECTRON MICROSCOPE



This electron microscope, constructed in the Siemens and Halske plant in Germany, at present has a useful magnification of 2000 diameters, but can be extended by employing higher accelerating voltages to about 30,000 diameters, which is 6 times as great as that possible with the best optical methods. Voltages up to 100,000 volts are used in the present work

time tensile properties at elevated temperatures present a ready indication of what may be expected.

The short-time ultimate tensile strength of the new alloy is unusually high at the usual operating temperatures of 500 to 800 deg. C. The alloy is fairly ductile and can be drawn into wire down to a diameter of about 0.003 in. It is readily formed over a mandrel. In addition, like the other nickel-molybdenum-iron alloy, its emissivity is not strongly affected by condensates of getter or cathode materials. Recently, however, to reduce grid emission still further, grid wire of these alloys has been gold plated and copper plated, and results of several tests conducted with this wire indicate that it has considerable merit.

## Abstract of Italian Papers on Electrical Science

A NEW INSTITUTION, known as the Centro Volti di Electrologia has been founded in Italy with the high consent of the Duce and the National Committee of Research. Its principal object will be the improvement of electrical knowledge by means of new cultural exchanges between Italian and foreign scientists. The society publishes the *Bulletin of the Centro Volti di Electrologia*, the purpose of which is the dissemination of Italian research in the field of electrical studies throughout the world.

The first issue of the *Bulletin* contains an outline of the organization of the society, an illustrated article on its center of activity, the stately Dendramin-Calergi Palace in Venice. Two technical articles, from other Italian publications, are given and almost 200 papers are abstracted from Italian sources. These abstracts are printed on individual cards 3 in. by 4 in. in English as well as Italian.

Annual subscription rate is 30 L. The *Bulletin* may be obtained from the Centro Volpi di Electrologia, Dendramin-Calergi Palace, Venice, Italy.

## Tubes as Voltage Recorders

THE USE OF gas tube voltage recorders as applied to telephone practice is described by L. K. Swart in the July issue of the *Bell Laboratories Record*. In telephone practice it is sometimes necessary to determine the magnitude and time of occurrence of voltages which are induced in telephone circuits from neighboring power lines. The desirable characteristics of not consuming power except when recording voltage fluctuations and being ready for operation continuously have been met in a voltage recorder controlled by cold cathode tubes which become conducting when the applied voltage exceeds a critical value. Records of disturbances with any desired range of voltages can be handled readily by using several tubes in a suitable circuit arrangement.

The cold cathode tubes employed have



# Station Power



Shown above is a busy scene in the main office of RCA Communications, located in the heart of downtown New York, 66 Broad Street. This is one of the many services of the Radio Corporation of America.

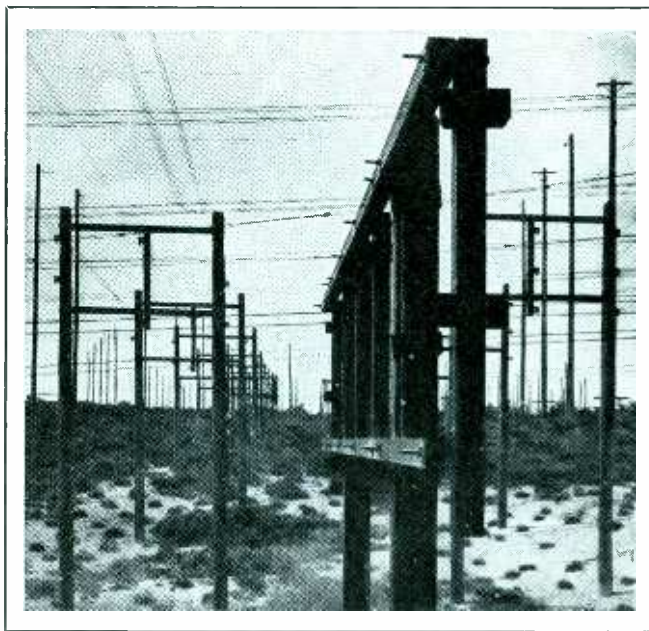

At the Riverhead, Long Island, receiving station of RCA Communications are scores of antennas. This is the point of reception of European features that are heard on hundreds of American radio stations.

**T**HE POWER of a broadcasting station is not measured in kilowatts alone, but in ability to hold an audience. The world-wide communications services of RCA may seem to have little connection with the power of broadcasting stations. But when power is considered in terms of audience rather than kilowatts the connection is clear. All radio broadcasting stemmed from communications. RCA research in this field has

constantly led to improvements in transmitting radio programs . . . more power to stations.

In the home no radio program is better than the radio receiver. RCA research has been responsible for a large part of the steady improvement in home receivers. This research is of a practical nature that not only improves instruments but makes them available at low prices. All of which means . . . more power to stations.



**Radio Corporation of America**

RADIO CITY, NEW YORK

RCA Manufacturing Company, Inc.

National Broadcasting Company

RCA Communications, Inc.

RCA Institutes, Inc.

Radiomarine Corporation of America

# HAVE YOU A DIFFICULT RESISTOR PROBLEM?



*Globar makes 4 distinct types of industrial ceramic resistors to help solve your problem*

**N**O one type of resistor can serve every purpose. So Globar makes, not one, but 4 distinct types of industrial ceramic resistors. That is why more and more people are coming to us for a solution of their difficult problems. We invite you, too, to let us help you.

Listed here are the characteristics of the 4 types of industrial resistors made by Globar:

1. Negative voltage
2. Straight light voltage-temperature
3. Negative temperature

4. Slight positive temperature and slight negative voltage

Choose from the table below any size, resistance or capacity . . . there will be at least one resistor from among the 4 Globar types which will exactly meet your specifications.

#### SIZE RANGE

Diameter: 1/8" to 1" Length: 3/8" to 18"

#### RESISTANCE RANGE

.05 ohms to 1.00 megohm per in. length

#### CAPACITY RANGE

In open air: 1 to 5 watts per sq. in.  
In oil bath: up to 30 watts per sq. in.

*The Globar Division*  
**THE CARBORUNDUM COMPANY • NIAGARA FALLS, N. Y.**

REG. U. S. PAT. OFF.

Sales Offices and Warehouses in New York, Chicago, Philadelphia, Detroit, Cleveland, Boston, Pittsburgh, Cincinnati, Grand Rapids

(Carborundum and Globar are registered trade-marks of The Carborundum Company)

two activated cathodes and a non-activated anode. They contain a mixture of gases at low pressure of which the most important constituent is either neon or argon. The circuit to be tested is connected to the two cathodes which act as the control electrode.

When the voltage across the two cathodes exceeds the breakdown or critical value, the gas in the tubes becomes ionized. The ionization within the tubes reduces the impedance of the circuit of which the anode forms an essential part and allows sufficient current to pass to actuate the recording relay equipment.

One method of extinguishing the tubes after the disturbing voltage is recorded makes use of a restoring relay which removes the actuating voltage from the message register as soon as the discharge has been recorded.

The simplified wiring diagram of Fig. 1 shows a single stage recorder

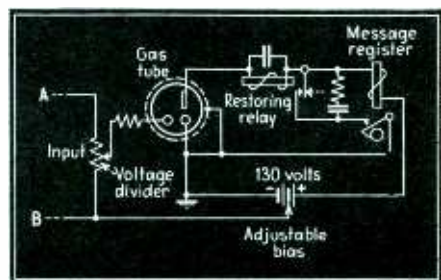

with one suitable method for restoring the tubes to normal use. By means of the voltage divider across the input circuit, the voltage at which the gas tube breaks down, in terms of the disturbing input voltage, may be varied at will.

Several types of voltage recorders have been constructed on these principles. The simplest are those in which a Veeder counter is actuated by means of a ratchet wheel whenever the message register is operated. Other recorders have been constructed to give on paper tape a permanent record of the magnitude of the voltage as well as the time of occurrence of the disturbance.

## METAL TUBES IN GERMANY



The use of horizontal element structures in a new series of metal tubes by Telefunken gives a compact assembly. Metal tubes are new in Germany and not yet popularized. Only one manufacturer's line features them in the present Berlin Radio Show



## Philips-Miller Recording System

A SYSTEM OF mechanical recording which is used with optical reproduction is described by R. Vermeulen in the June issue of the *Journal of the Society of Motion Picture Engineers* under the title "The Philips-Miller Method of Recording Sound". The method of recording is mechanical in operation and is suitable for "playback" immediately after being produced, since it does not require processing.

The sound track is engraved upon a strip of film composed of a celluloid base which is coated with a layer of transparent gelatin about 50 microns thick, upon which is superimposed a very thin opaque coating, about 3 to 5 microns thick. A cutter in the shape of an obtuse angle wedge is displaced perpendicularly to the plane of the film strip in synchronism with the sound vibrations to be recorded. The cutter removes a shaving from the gelatin layer passing below it and in so doing leaves

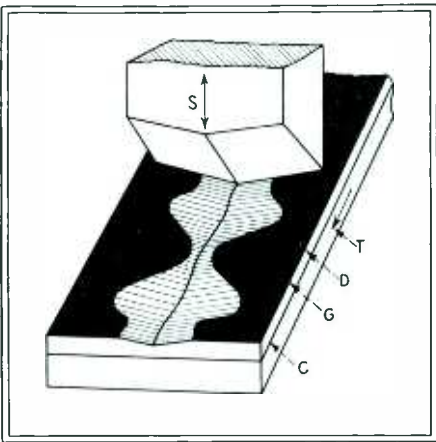

Cutting head of the Philips-Miller recording system, showing removal of opaque coating from transparent base

a transparent trace against an opaque background. Because of the shape of the cutter, the transparent trace produces a linear magnification of the cutter motion. When only the center of the cutter is effective, a narrow trace is recorded, but when the cutter is depressed several microns, the slit widens considerably.

Because the recording is mechanical in operation and does not require subsequent processing, the film strip can be handled throughout in ordinary daylight. Through the use of an optical reproducing system, a long playing time is obtained, the wear on the sound channel is small, while the absence of mechanical reaction upon the sound film drive enables a low power drive unit to be employed.

The article discusses suitable angles which have been determined for the cutting head, the frequency characteristics of the recorder or cutter, shows the construction of the driving system, and discusses the advantages of this recording system over the customary photographic methods of recording.

## Important Chasm Closed With

## COMPENSATED MICRODYNE

Pioneer in instantaneous recording, Presto Recording Corp., maintains its reputation, we believe, by its devotion to the quality ideal. This company recently tested many pickups of various types—For Presto says—there is no point in putting wide range on a record unless the pickup will reproduce it.

After exhaustive tests of all these pickups, Presto found the smooth frequency response, fine wave form and distortionless performance of the AUDAX COMPENSATED MICRODYNE so far ahead of all the others, as to bear no comparison.

Said Presto,—“The new AUDAX COMPENSATED MICRODYNE closes the chasm between microphone and pickup and at last makes it possible to reproduce everything that the microphone puts on the record.”

However, when it came to their lowest priced machine, the sales department, in view of price considerations, feared that it might be necessary to use a cheaper type pickup for this model,—and here is where the engineering and sales departments clashed.

*Everything considered, such as range, wave form, absence of peaks, and smooth distortionless performance, you will find even the lowest priced AUDAX MICRODYNE incomparably superior to any other commercially available pickups,—regardless of price.*

A complete line of AUDAX PICKUPS is available from \$8.00 to \$175.00 list.

Write for literature on the new COMPENSATED MICRODYNE Pickups, etc.

# A U D A K C O M P A N Y

500 FIFTH AVENUE NEW YORK CITY

“Creators of High Grade Electrical and Acoustical Apparatus Since 1915”



The Presto engineers then let the different pickups stand for a couple of weeks (during August) after which they were tested again—and all,—except AUDAX COMPENSATED MICRODYNE,—had undergone a drastic change which automatically eliminated them. AUDAX COMPENSATED MICRODYNE performance was not only found incomparably superior, but, of all the various types tested, it was the only one which maintained that superior performance remaining immune to the elements.

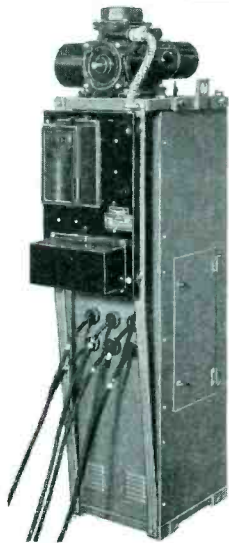

Above: Type TCA Transtat Regulator—a fully automatic line-voltage compensator

Below: Type LC Transtat Regulator—a manually operated line-voltage compensator.



## Do you need accurate VOLTAGE CONTROL?

**E**FFICIENT control of voltage to all plate, filament and bias circuits is now possible with greater accuracy and at lower cost through the use of Transtat Voltage Regulators. This new AmerTran product is an adjustable auto-transformer regulator which offers both the smoothness of control of a potentiometer and the high efficiency, good regulation and flexibility of a transformer. Types are available for manual, motor and full automatic control, for single-phase and polyphase service, and for loads from 0.5 Kva. to 200 Kva.

In radio transmitter circuits Transtat Regulators may be used advantageously to (1) maintain input (line) voltage at a constant value, (2) lower input voltage to plate transformers for reduced power operation without program interruption, (3) increase gradually the filament voltage to large tubes, and (4) obtain special voltages for laboratory and experimental work. May we send you data on equipment for your requirements?

### AMERICAN TRANSFORMER CO.

178 Emmet St.,



Newark, N. J.

# AMERTRAN

## AMERTRAN ELECTRONIC PRODUCTS

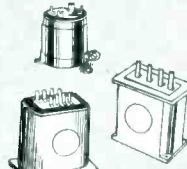

AUDIO FREQUENCY COMPONENTS

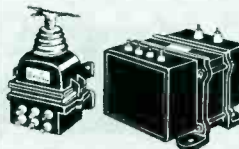

AIR INSULATED RECTIFIER COMPONENTS



MANUALLY OPERATED VOLTAGE REGULATORS

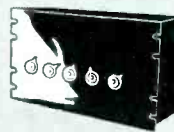

LINE EQUALIZERS

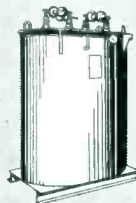

OIL IMMERSED TRANSFORMERS

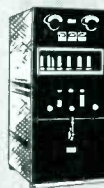

RECTIFIERS

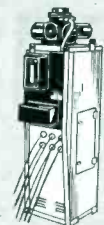

AUTOMATIC VOLTAGE REGULATORS

## A New Type of Vacuum Steel

A NEW TYPE of lead-in structure for vacuum-, gas-, or oil-tight chambers is described by W. E. Dahls, in the July issue of *Electrical Engineering*. In this seal, porcelain bushings are sealed to metal by means of a glass which serves as a bonding agency. The advantage of using porcelain rather than glass as a seal to metal is that the porcelain will maintain its shape to much higher temperatures than glass, and therefore only a minimum amount of skill and labor would be required to make the joint.

The prerequisites for making an ideal seal between glass, metal and porcelain are: (1) both the metal and porcelain must be wet by the glass; (2) the metal, glass and porcelain must all have the same coefficients of expansion up to the temperature where the glass is sufficiently viscose to relieve stresses quickly; (3) all component parts must be vacuum tight. In practice the proper requirements need only be such that the metal, glass and porcelain should have coefficients of expansion sufficiently alike that upon cooling after the seal is made, the stresses developed due to the differences in thermal contraction are not great enough to cause a fracture of the glass or porcelain, or to leave the completed seal mechanically weak.

In this article the requirements for suitable glass porcelain metal seals are discussed as well as the wetting of the materials by the glass, and the thermal expansion of the three substances.

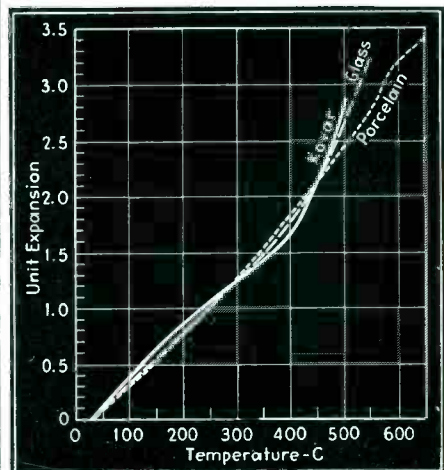

Fig. 1—Expansion characteristics of metal glass and porcelain suitable for making vacuum tight seals

Fig. 1 shows the expansion characteristics of the three materials used in one type of seal. This seal is made at a high temperature (usually between 900 and 1100 deg. C.) and consequently, the Kovar metal and glass have expanded considerably more than the porcelain. After the seal is made and cooling is started, the metal tends to contract faster than the porcelain and consequently stresses are set up in the seal. In order that these stresses may be relieved at the lower temperature, the glass must permit the metal to move with respect to the porcelain by an



amount equal to the difference in contraction between the metal and porcelain in cooling from the temperature at which the seal is made to the lower temperature.

An analysis given by the author shows that it is impossible to obtain complete release of stress in a metal-glass-porcelain seal for a heat treatment of any reasonable time. By so adjusting the seal design that stress release will continue to as low a temperature as practically feasible, a satisfactory, strong seal can be made.

### Shape of the Magnetron Characteristic

AN ATTEMPT to determine the shape of the cut-off curve in magnetrons from theoretical consideration is given in an article by E. G. Linder, "Effects of High Energy Electron Random Motion Upon the Shape of the Magnetron Cut-Off Curve" published in the May issue of the *Journal of Applied Physics*.

In this article, the differential equations of motion for electrons in the magnetron are derived and experimental verification of the theory is given.

In a perfectly symmetrical, cylindrical magnetron, neglecting space charge effects and the initial velocity of the electron, and assuming that the electrons move only under the action of the electric and magnetic fields, the cut-off curve would have the general shape shown in Fig. 1 A. The anode cur-

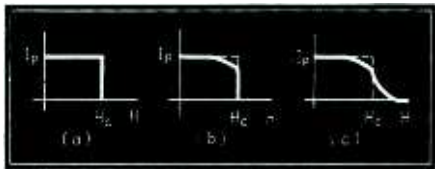
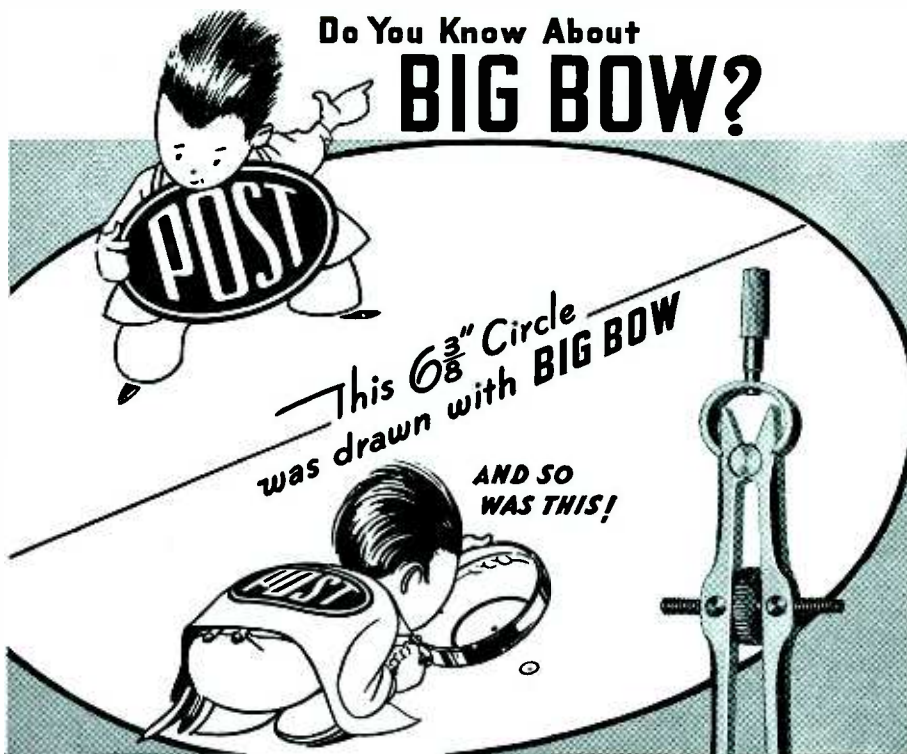

Fig. 1 — Magnetron characteristics for various emission conditions

rent  $I_a$  remains constant until the magnetic field reaches the critical value  $H_c$  when  $I_a$  drops abruptly to zero. If the space charge is considered, the anode currents no longer remain constant as the magnetic field approaches its critical value. The increasing curvature of the electron trajectories and the longer transit time cause an increase in space charge and a consequent decrease in anode current before the cut-off point is reached. However, when the magnetic field reaches its critical value  $H_c$ , the anode current drops abruptly to zero as shown in Fig. 1 B. If initial velocities are also considered the curve takes the form shown in Fig. 1 C where the first part of the curve is identical with that of Fig. 1 B. For field intensities greater than  $H_c$  an abrupt drop in anode current no longer occurs. At the critical point, only those electrons having zero initial velocity fail to reach the anode, but those having a higher initial velocity require greater fields for their cut-off. This yields a curve of the form shown, which is the form always observed experimentally if the emission current is sufficiently large to cause appreciable space charge.



## ... yet BIG BOW is only 5 inches overall

Draftsmen need fewer instruments when more usefulness is designed into each one. That's why Post—wherever practicable—builds an added scope of usefulness into each instrument. Thus the Post-equipped draftsman needs fewer instruments, spends less time reaching—more time drawing.

The *extra-functional* scope of Post instruments plus a carefully achieved balance increases the usefulness of each instrument, increases the quality of drawing, increases the satisfaction of the craftsman with his tools.

Try Big Bow or any POST instrument on a 7 day free trial.

Engineering Instruments  
Equipment  
Material  
Blue Print Papers and Kindred  
Sensitized Products

Just phone or write your nearest POST man in this nationwide POST network.

**BIRMINGHAM**  
James A. Head, Inc.  
**BOSTON**  
Boston Blue Print Co.  
**BUFFALO**  
Buffalo Blue Print Co.  
**CHICAGO**  
The Frederick Post Co.  
Horders, Inc.  
**CLEVELAND**  
The City Blue Printing Co.  
**DALLAS**  
The Rush Co.  
**DAYTON**  
The Gem City Blue Print & Sup. Co.  
**DENVER**  
H. R. Meininger Co.  
**DETROIT**  
The Frederick Post Co.  
**FORT WAYNE**  
Fort Wayne Blue Print & Supply Co.  
**FORT WORTH**  
Majestic Reproduction Co.  
**HOUSTON**  
Gulf Blue Print Co.  
**INDIANAPOLIS**  
Indianapolis Blue Print & Litho. Co.

**KANSAS CITY**  
Western Blue Print Co.  
**KNOXVILLE**  
Sehorn & Kennedy  
**LOS ANGELES**  
Stationers Corporation  
**MILWAUKEE**  
Frederick Post Co. of Wisconsin  
**OKLAHOMA CITY**  
The A. & E. Equipment, Inc.  
**PHILADELPHIA**  
Philadelphia Blue Print Co.  
**PITTSBURGH**  
American Blue Printing Co.  
**PORTLAND**  
The J. K. Gill Co.  
**ST. LOUIS**  
Service Blue Print & Photo Copy Co.  
**SEATTLE**  
Kuker-Ranken, Inc.  
**TOLEDO**  
Toledo Blue Print & Paper Co.  
**TULSA**  
Triangle Blue Print & Supply Co.

DID YOU GET YOUR *Symbol Chart*?

There's nothing like it. 249 useful drafting symbols all on one wall chart. Your POST man has one for you FREE.



# THE INDUSTRY IN REVIEW

## Fabricated Plate Capacitors . . . . . By Gordon V. Peck\*

**O**F WIDESPREAD interest to those engaged in radio chassis and circuit design, is the recent announcement of the type FP capacitor incorporating the newly developed anode material known as "fabricated plate". Since this new anode material represents a fundamental capacitor development, a brief review of the capacity characteristic and industrial history should be of interest.

The capacity of a dry electrolytic unit is determined by the surface area of the anode exposed to the electrolyte and the thickness of the anode film. Capacitance is developed in the insulating oxide film which lies between the anode plate and the electrolyte, which is the cathode electrode. The so-called cathode foil is used for the sole purpose of establishing a low resistance contact to the electrolyte and its surface area has no bearing on the anode capacity.

In paper dielectric capacitors, the capacitance is developed between the two metallic electrodes and not between one electrode and the electrolyte as in electrolytic units. No capacity gain, through added surface area, is possible unless the electrodes are actually increased in physical size.

Early types of dry electrolytic capacitors were made with plain aluminum anode foil and were commercially identified by Type SP representing "smooth plate".

Approximately four years ago etched plate Type EP dry electrolytic capacitors were made available and their use has increased through the intervening years. The Type EP capacitor provided the first commercial realization of capacity gain through increased anode area and made possible a substantial decrease in physical size over the original smooth plate type.

In the case of etched plate capacitors, the increased anode surface area was accomplished through a special acid etching process. Anode plate, prepared in this manner, produced ratios, as compared to smooth plate of an average of 4 to 1. The capacity ratio of etched plate units varies somewhat with forming voltage.

Now, however, aluminum foil and the subsequent roughening methods are being supplanted by the latest anode development known as fabricated plate produced by spraying molten aluminum directly onto a chloride-free fabric carrier and commercially identified as "FP" plate. The process is accomplished through specially designed automatic machinery that turns out this FP plate at high speed.

Some years ago the first experiments involving the spraying of aluminum for anode development were carried on in the Magnavox plant at Fort Wayne, Indiana. While the original work done in this regard was confined largely to spraying aluminum onto aluminum foil for use as wet electrolytic anodes, considerable experience and technique were accumulated which helped make fabricated plate possible. Later, the Mallory Research Division started the commercial development of the fabric carrier type of sprayed plate now in current use by both companies.

Of outstanding interest is the high ratio obtainable and the consequent reduction in capacitor size made possible through the fabricated plate development. The high ratio is obtained by utilizing the entire thickness of the plate and the great surface area afforded by

the many threadlike fibres of the fabric which are coated with a continuous layer of aluminum. FP plate is porous, and light may be seen throughout its entire area. Naturally, this porosity permits excellent electrolyte contact during impregnation with consequent low series resistance characteristics.

Unlike etched plate anode foil, which varies considerably in ratio with forming voltage, fabricated plate, due to its welded particle structure, is practically unaffected. This largely accounts for the remarkably uniform capacity characteristic of FP plate and permanency of this characteristic throughout the life of the capacitor.

The ratio of 10 to 1, temporarily adopted as standard for all FP plate, does not represent the maximum ratio attainable. Fabricated plate capacitors with a ratio of 20 to 1 have been made in the laboratory. While ratios of 30 to 1 and higher have been obtained experimentally, the practical ratio limit has not been determined at this writing.

Aluminum for the spraying operation is purchased in wire form, which is readily obtainable in the high purity desired for anode material. This assures uniform production of capacitors having excellent shelf and operating life characteristics. The use of a single standard gauge of wire for all spraying purposes completely rectifies an inventory problem formerly encountered in the necessity of stocking large quantities of numerous gauges and widths of foil for anode purposes.

Electrical connection to the anode in foil type capacitors was made by cutting and folding a portion of the foil to form a tab to which the terminal or lead wire was riveted. The tabbing of fabricated plate is accomplished by inserting a special aluminum tab at pre-determined intervals along the fabric carrier, the tabs being welded permanently into position by the molten aluminum from the spray guns. This new tab is the culmination of extensive development work and provides advantages with regard to capacitor construction details and operating efficiency generally impossible with the fragile foil tabs used on the original anodes.

In developing the most practical capacitor design for housing the fabricated plate cartridge, the metal cased Type FP capacitor first announced to the trade in March 1938 was evolved. This unique, completely standardized capacitor permits, for the first time in this industry, low cost mass production of a compact trouble-free unit having an exceptional range of application.

\* P. R. Mallory & Co., Inc.

### Radiotron General Manager



Eugene W. Ritter, one of the radio industry's best known young men, made general manager of the Radiotron plant of RCA. Succeeding Mr. Ritter as director of research and engineering, is D. F. Schmit whose experience in vacuum tube engineering dates from 1923



♦ National Antenna Check-Up Week is scheduled for the week of October 15 to 22. The basic purpose is to stimulate interest in better radio reception and service just prior to the opening of the radio broadcasting season, according to its sponsors, the Belden Manufacturing Co. . . . A statement of income of the Radio Corporation of America released August 3 for the second quarter of 1938 shows a net profit of \$1,186,955.54 which was \$1,317,373.30 less than the net profit of the same quarter of 1937, while the net profit for the six months period is \$2,524,756.50. . . . H. F. Mickel has been appointed Manager of the RCA Police Radio Section to succeed P. A. Anderson who has resigned. George W. Pettingill has been appointed assistant to Mr. Mickel. . . . Raymond Szymanowitz, formerly technical director of Acheson Colloids Corporation has been moved up to vice president and technical director of Acheson Industries, Inc., technical development company for the Acheson interests. In his new capacity, Mr. Szymanowitz will continue supervision of all research activity of Acheson Colloids Corp., Port Huron, Mich. . . . An autopsy revealed that the death of Mr. John Chester Warner, who was vice-president of the RCA Manufacturing Company in charge of the Radiotron Division at Harrison, N. J., was caused by injuries received in an automobile accident rather than heart failure as was first believed. . . . The Supreme Instruments Corporation, Greenwood, Miss., test instrument manufacturers, announce that Mr. E. G. Perkins of its Engineering Department is now in charge of High Frequency Test Instrument design. . . . Transducer Corporation announces that the Tilton Electric Corporation of 15 East 26th Street, New York City, has been appointed exclusive distributors for the world for Bullet microphones. . . . University Laboratories, makers of high efficiency internally folded air column trumpets and PM dynamic driver units for PA use, moved to 195 Christie St., New York, on September 1. . . . H. A. Marsh Advertising Agency, New York, has added to its staff Mr. Gene Turney (W2APT) in line with their "desire to be of the widest possible assistance in rendering technical advertising service to manufacturers in radio and electrical industries."

Literature

TAG Instruments. 64-page catalog of indicating, recording, and controlling instruments. Catalog and bulletin No. 1060D. C. J. Tagliabue Mfg. Co., Park and Nostrand Aves., Brooklyn.

**NOW—ALL the ADVANTAGES of TRUE UNI-DIRECTIONAL PICK-UP AVAILABLE at REALLY LOW COST**

★ *Sensitive at Front and Dead at Rear*

**NEW SHURE UNIPLEX**

*Really Solves Feedback Background Noise and Reverberation Problems*

THE development of this remarkable new UNIPLEX by Shure Engineers literally opens the way to better sound pick-up in countless microphone installations everywhere. For it places all the advantages of uni-directionality within the reach of every sound engineer—it makes true uni-directional operation possible for the first time at such amazingly low cost! The UNIPLEX Crystal Microphone has a smooth, high quality wide-range front-side response, yet is practically unaffected by sound approaching from the rear. This means freedom from feedback, the practical elimination of crowd and background noise, and remarkable reduction in reverberation "room effects." In appearance, the UNIPLEX is equally outstanding with its distinctive new shape, speed lines and rich new Satin Chrome finish. Tilting head. Equipped with new Shure built-in Cable Connector and 25 ft. of special new noise-free Super-Shielded cable. **Model 730A UNIPLEX** (Code: Rupel) List Price. **\$29.50**

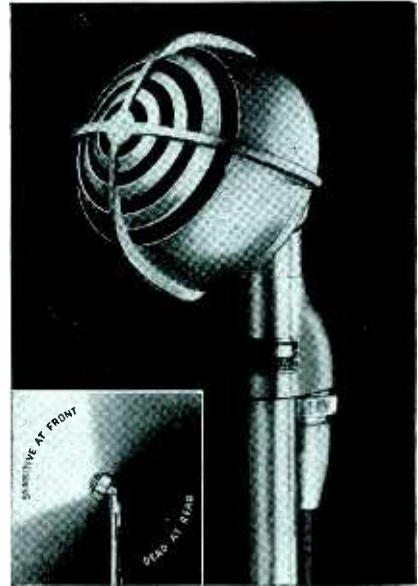

**NEW ROCKET CONVERTIBLE**

This new Model 705A ROCKET Crystal Microphone has all the features of Shure "Ultra" Wide-Range design — insures faithful sound reproduction — and permits easy convertibility from conventional to semi-directional and non-directional pick-up. Tilting head easily



**New Shure Super-Level**

aimed at source of sound. Satin Chrome finish overall. Equipped with new Shure built-in Cable Connector and 25 ft. shielded cable. **Model 705A ROCKET**. List Price . . . . . **\$25**

Model A91A Directional Baffle may be added to the ROCKET (as shown at right) to reduce pick-up from sides and rear at the higher frequencies, decrease feedback tendency and cut down room-noise pick-up. It lists at \$2.50



This popular Shure 70H now has the highest output level ever available in a crystal microphone. Rated at 46 db. below 1 volt per bar. Requires less amplifier gain. New Satin Chrome finish overall. Has new built-in Cable Connector and 7 ft. shielded cable. **Model 70H SUPER-LEVEL**. List Price **\$22.50**

"SOUND SYSTEMS SOUND BETTER WITH SHURE MICROPHONES"

**Write today for Catalog 150M for complete data.**



Shure Patents Pending. Licensed under patents of the Brush Development Company.

# AUTOMATIC ELECTRIC

makes **MORE** relays . . . . .  
 makes **BETTER** relays . . . . .  
 makes **MORE VARIETIES** of relays

**THAN ANY OTHER  
 MANUFACTURER!**

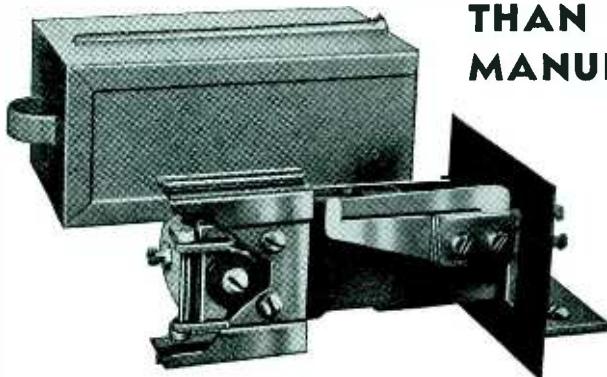

AND—when you buy an Automatic Electric Relay you get a precision product designed and constructed by an experienced company—for Automatic Electric has been making relays **LONGER** than any other manufacturer!

## Relays for EVERY INDUSTRIAL Need

- The Automatic Electric line of relays includes quick and delayed action types, sensitive and heavy duty types, mechanical locking types, polarized relays, etc. Available with any contact combination and for operation on D. C. or A. C. circuits of any voltage.
- Write for complete illustrated catalog of relays, stepping switches, electric counters, solenoids, keys, and other electrical control accessories. Address American Automatic Electric Sales Company, 1033 W. Van Buren St., Chicago.

## AUTOMATIC ELECTRIC

MAKERS OF TELEPHONE AND SIGNALING APPARATUS  
 ELECTRICAL ENGINEERS, DESIGNERS AND CONSULTANTS

## CALLITE TUNGSTEN — MOLYBDENUM

- Grids
- Plates
- Cathodes
- Copper-clad
- Formed Parts
- Hooks and Pigtails
- Trimet Lead-in Wire
- Tungsten Filament Wire
- Molybdenum Anchor Wire
- Special Filament Springs
- Two and Three-Piece Welds for Hard and Soft Glass

We maintain a competent staff of engineers ever at your service to assist you. Write for additional information and let us help you with your problems.

## CALLITE PRODUCTS DIVISION

EISLER ELECTRIC CORPORATION

544-39th STREET UNION CITY, N. J.

**Transformer Components.** A special series contained in bulletin No. S-10A which includes amplifier kits and transmitter kits. United Transformer Corp., 72 Spring St., New York City. Bulletin R-20A contains radio set replacement transformer information.

**Test Equipment.** Tube testers, multi-range meter assemblies, signal generators, etc. Form 39. Precision Apparatus Corp., 821 E. New York Ave., Brooklyn, N. Y.

**Electric Eye Devices.** New catalog information by Photobell Corp., 96 Warren St., New York City.

**Footprints.** House organ on chemicals, metals, alloys and ores of Foote Mineral Co., 16th & Summer Sts., Philadelphia, Pa.

**Wire and Cable.** Bulletin includes antenna systems, hook-up wire, transmission lines, etc. Belden Mfg. Co., 4647 W. Van Buren St., Chicago, Ill.

**General Radio Experimenter.** July, 1938. Articles on portable stage-lighting control, shielded connectors for a-c measurements, and radio receiver tests. General Radio Co., Cambridge, Mass.

**Developing Machines.** Types 2500, 1000, 3500, and 600. Described in separate bulletins. Ozalid Corp., 354 Fourth Ave., New York City.

**Automatic Changing Units.** Record players also described in catalog. Gerard Sales Corp., 17 Warren St., New York City.

**Photoelectric Equipment.** "The Light" is condensed illustrated outline describing work of Luxtrol Co., 54 West 21st St., New York City.

**Standardized Metal Equipment.** Racks, panels and cabinets for sound industry. Catalog 38. Par-Metal Products Corp., 35-25 41st St., Long Island City, N. Y.

(Continued on page 68)

## New Products

### Tube Tester

AN INEXPENSIVE, accurate tube tester, the new "dynoptimum", has been put on the market by Radio City Products Company, 88 Park place, New York. This instrument tests all of the latest type tubes as well as old types, including the new OZ4 and other cold cathode rectifiers. It tests all metal, MG spray shield and glass tubes, all ballast types.

Hot interelement shorts and leakage between all individual elements, hot cathode leakage, sectional defects of full wave rectifiers, duo diodes and all multi-purpose tubes are tested. The meter is a three inch D'Arsonval, 2% accuracy, with a direct reading "Good-Bad" multi-colored scale and calibrated reference scale. Directly on the meter is an accurate line voltage indicator, smoothly controlled for line voltage variation.



## STABILIZED CAPACITORS

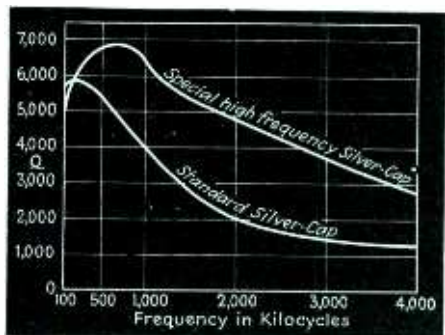
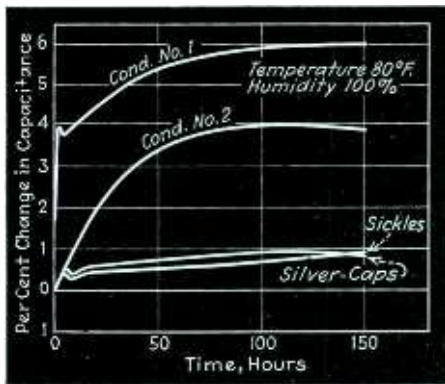

A most significant development of recent origin is that of tuning components which are remarkably stable with changes in humidity and temperature. The curves above show a direct comparison of the capacity stability between two standard moulded mica condensers and a two Silver Cap (Sickles) units at 80 deg. F and 100 percent humidity. The lower curve gives readings of Q over a wide band of frequencies

### Remote Control Tube

RAYTHEON type RK-62 is a gas-filled triode which may be used as an extremely sensitive detector of high frequency signals.

For controlling model airplanes, the tube appears to be unequalled. It is operated in the standard self-quenching super regenerative circuit in which the usual phones are replaced by a sensitive relay and a low capacity bypass condenser. One model plane may have three or four of these receivers tuned to different frequencies. Transmitters on the ground are used to actuate the relays and each performs some function necessary to operate the plane realistically.

Other Raytheon tubes recently announced are the RX884 and RX885. These are gas filled triodes designed for sweep circuit oscillators or grid controlled rectifiers. The former has a 6.3 volt filament; the latter operates from 2.5 volts.

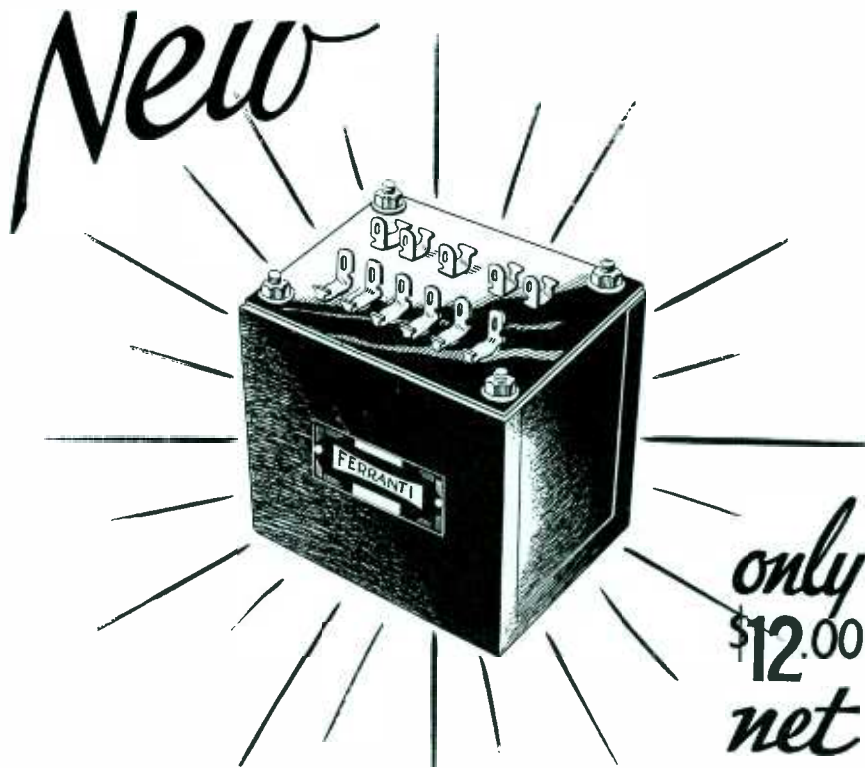

only  
\$12.00  
net

## Multi-Shielded Input Transformer "Type A-216X"

Check these **FACTS (not claims)** . . . .

- Multi Shielded Mu Metal Case *plus*
- Two Leg Hum Bucking Coils *plus*
- Low Level Operation *plus*
- Ferranti Compact Reversible Mounting *plus*
- High Fidelity Frequency Response *plus*
- Electrostatic Shields between Primary and Secondary Windings *plus*
- Balanced Primary and Secondary Windings *plus*

**Ferranti Quality Throughout!**

### TECHNICAL DATA

Primary 50/200, 125/500 ohms  
Secondary 15,000/60,000 ohms  
Line to Single or Push Pull Tubes  
Maximum Operating Level  
+ 20 db

Primary D C per Leg 50 mils  
Primary unbalance 4 mils  
Case Completely Reversible

Complete shielding makes this NEW Transformer particularly effective in the input circuit of High Gain Amplifiers.

2 3/4" x 2 1/8" x 2 7/8"  
Mtg. 2 1/8" x 1 5/8"  
Wt. 2 lbs.

*Ferranti Electric Inc.*  
R. C. A. BUILDING, NEW YORK, N. Y.



# SPEAKERS

BUILT TO YOUR

SPECIFICATIONS

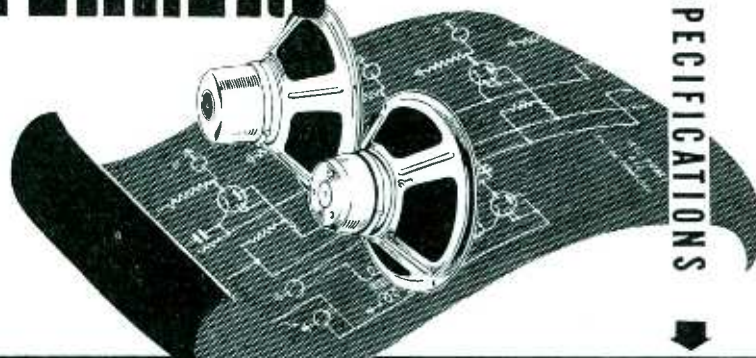

**N**EXT to lasting dependability, what engineers like most about CINAUDAGRAPH speakers is the versatility of the line. They know that if CINAUDAGRAPH doesn't have a unit to fit their needs, CINAUDAGRAPH will build it for them . . . build it soundly, thoroughly, exactly to SPECIFICATION. Take advantage of this exclusive service, and get the extra-value of exclusive design, specialized engineering and construction that CINAUDAGRAPH is able to offer at competitive prices. *Your inquiry is invited.*

Cinaudagraph speakers are now available in electro-dynamics from 5" to 27" and P.M.'s from 5" to 18".

## CINAUDAGRAPH CORPORATION

DEPT. 4J SPEAKER DIVISION  
STAMFORD, CONNECTICUT

EXPORT DEPARTMENT  
100 VARICK ST., NEW YORK



★  
Send for New  
Catalog 17 today  
—or let Ohmite  
Engineers work  
out your particu-  
lar control-by-re-  
sistance problem.

### LOCKHEED PLANE OHMITE - EQUIPPED

Hughes' dash around the world in his LOCKHEED Plane adds another "case history" to the service-record of Ohmite Vitreous-Enamelled Rheostats and Resistors. Their ability to withstand overloads and abuse, shock and vibration, heat and humidity, has made them standard equipment on such major airways as Pan-American, United Air Lines, and others both here and abroad—as well as in the general electronics, radio and industrial fields.

OHMITE MANUFACTURING COMPANY  
4825 W. Flourney Ave., Chicago, Illinois, U. S. A.

**OHMITE**  
RHEOSTATS ★ RESISTORS ★



TAP SWITCHES

### Photoelectric Control

FOR USE in all general applications is Model No. 50 of the United Cinephone Corp., 43-37 33rd St., Long Island City, N. Y. The relay is complete with light source of a 32 CP automobile type bulb. It operates control at distance of 25 ft. 110 volt 60 cycles AC. The internal telephone type relay carries a load of 2 amps. 110 volt 60 cycles A.C. non-inductive. Impulses required are  $\frac{1}{20}$  of sec. between operations. The unit contains one 6J5 amplifier tube and one 1105 photocell. The lens is a 2" focal length Bausch & Lomb.

### Cased Bypass Condensers

NEW P. R. Mallory Cased Bypass Condensers, Type CB, are now available in two working voltages, 400 and 600, a wide variety of capacities, and in single and multiple section types. For convenience Mallory has combined the usual 200-volt listing with the 400-volt ratings but has retained the small size of the 200-volt type. This eliminates unnecessary items. In making this change the insulation of former 200-volt units was increased to equal the required insulation for 400-volt rating.

### Glass Insulated Magnet Wire

A NEW Deltabeston magnet wire, insulated with fiber glass, has been announced by the General Electric Co., Bridgeport, as an addition to the present line of Deltabeston asbestos-insulated magnet wire. Deltabeston glass-insulated magnet wire, like Deltabeston asbestos-insulated magnet wire, is available in round, square, and rectangular shapes.

### Condenser Tester

AN A-C BRIDGE for measuring leakage of electrolytic condensers has been developed by Clough-Brengle, Chicago. This Model 130 unit has a capacity from 1  $\mu$ f to 100  $\mu$ f, resistance from 10 ohms to 500 megohms, power factor of condensers from 0 to 50%, and transformer turns ratios from .01 to 100.

### Police Radio Transmitter

DESIGNATED as MI-7814, the new transmitter is wholly self contained and requires no external power supply. Class "A" high level modulator provides 100% modulation. It includes a convenient sized hand-type mike with a switch to control the transmitter built into the microphone. Two pilot lights on the instrument panel indicate the transmitter's operation. It is crystal controlled. Battery drain is 18 amps. for 8 watts output on the uhf band. R.C.A. Mfg. Co., Camden, N. J.

RCA also announces 25-watt PM speaker (MI-6260) for indoor and outdoor applications where a small, lightweight unit of good performance is required. Frequency range 140 to 8000 cycles.



## Capacitors

HERMETICALLY sealed in round aluminum containers, the Type TLA Cornell-Dubilier (South Plainfield, N. J.) capacitors are impregnated and filled with fire-proof Dykanol, the same high dielectric impregnant as used in the TJ-U transmitting capacitors. The capacitors are suitable for use in high power amplifiers and medium powered transmitters.

Physical size and shape of the containers of these capacitors simulate electrolytic capacitors, allowing for simple and neat assembly into power unit. The staple characteristics of Dykanol permits the operation of these capacitors at 10% above rating without injury to unit. Details in new catalog No. 161.

## Ignitron Welding Timer

TYPE SP-11 of Westinghouse is inexpensive, and will mount two sizes of ignitron tubes. On low duty cycle, the WL-652 tube will carry 1500 amps. at 220, 440 or 550 volts, while the WL-651 will carry 2800 amps at 440 and 550 volts or 4300 amps. at 220 volts. The current rating is decreased at duty cycles above about 3.5%. Other qualities are: high accuracy of control; adjustable to pass current for any exact

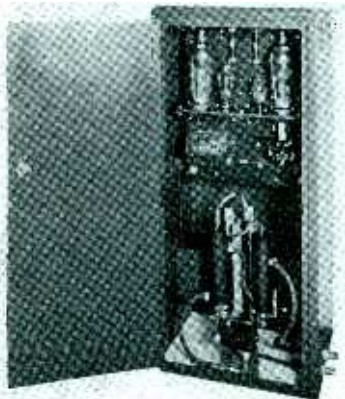

number of cycles from 1 to 15; for longer periods, it is adjustable from 1 to 30 cycles; welding machine current starts and stops at current zero eliminating line current transients.

THE Westinghouse 37 line of panel instruments covers industrial and radio applications and includes rectox types, thermocouple types, a-c and d-c meters.

## Insulated Test Clips

A NEW AND improved product made from neoprene, I. E. Du Pont de Nemours, (Wilmington, Del.) chloroprene rubber has been introduced by the manufacturers, Muelier Electric Co. This material exhibits the properties of rubber strength, resilience, elasticity and abrasion resistance and will maintain these properties virtually unchanged after extended exposure to oils, chemicals, heat, ozone and aging.

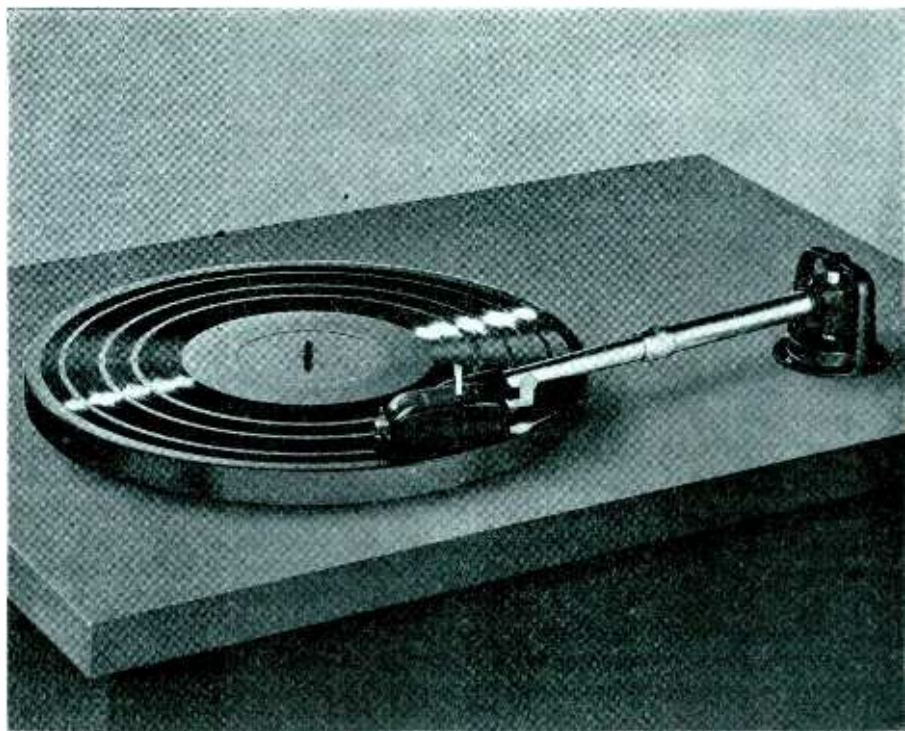

## THE BRUSH S-16 PICKUPS GIVE *Life Insurance on Records*

★ With the Brush S-16 pickups, it is possible to accomplish hundreds of playbacks from direct recording acetate records before objectionable scratch is experienced. Were this feat attempted by pickups other than the Brush high fidelity type, complete ruination of the acetate recording would result.

★ Other features of this pickup include:

1. True reproduction with needle pressures as low as three quarters of an ounce, and needle pressures conveniently adjustable in three positions up to two ounces for satisfactory reproduction under adverse conditions.
2. Permanent point, whose life is greater than 10,000 playings on shellacked pressings and after this time can be easily and economically replaced.
3. Perfect tracking with adjustable arm length from 12" to 16" and once adjusted for a particular turn table will remain fixed.
4. The arm swivel member is engaged by two combination thrust and radial ball bearings, permitting remarkably free movement of the arm.
5. Single set screw adjustment permitting height of arm variations from three quarter inch to one and one half inches, accommodating most any turn table.

This sort of protection and performance should be interesting to the recording enthusiast and every recording and broadcast engineer. Write for complete details.

**THE BRUSH DEVELOPMENT CO.**  
3316 Perkins Avenue  
CLEVELAND, OHIO

**ALLEN B. DU MONT**  
PASSAIC

**LABORATORIES Inc.**  
NEW JERSEY

RE:- AN EDUCATIONAL ESSENTIAL  
DU MONT CATHODE RAY OSCILLOGRAPHS

Dear Professor:-  
Here is an ideal means for presenting a visual demonstration of a circuit under operating conditions. These versatile Du Mont instruments lend themselves to educational work in all branches of electrical communications and power; in acoustics and for demonstrations of practically all physical phenomena.

We invite you to write for our new catalogue which describes the various models of Du Mont Oscillographs and Cathode Ray Tubes.

Respectfully,  
Allen B. Du Mont Laboratories, Inc.

*Allen B. Du Mont*  
Allen B. Du Mont - Pres.

AED/AA

Manufacturers of  
CATHODE-RAY-TUBES OSCILLOGRAPHS AND SCIENTIFIC INSTRUMENTS

## Modulation Indicator

To WARN of over-modulation the Modulate is a gas-filled glass tube 12 in. long and 16 mm in diameter. The inside of the glass is coated with fluorescent material which glows when excited by positive ions or by u-v when it is connected to the r-f stage of a transmitter. Over-modulation is evidenced by a red glow in the tube. It is useful for amateur and other transmitters which are required by rules of the FCC not to over-modulate. Acoustic Consultants, Inc., Rockefeller Center, New York.

## Portable Pee Wee Transmitter

COMPLETE TRANSMITTER and power supply on a single small chassis and operating from a 6 volt storage battery, this unit is primarily intended for rural service where a-c is not available or as a portable mobile or emergency transmitter. The current drain is 9 amps. fully loaded with key down and 1.4 amps. at standby. It contains metal rather than glass tubes. General Transformer Corp., 1295 W. Van Buren St., Chicago, Ill.

## Television Capacitors

TWO NEW TYPES of Pyranol capacitors, one designed for use in television transmitting sets and the other for radio transmitting sets, have been announced by the radio transmitter division of the General Electric Company, Schenectady.

The television capacitor, for use in kinescope deflecting circuits, is approximately 2 inches in diameter and 9 inches long, excluding leads. It is equipped with a heavy-duty ceramic insulator at the high-voltage terminal, and a molded Textolite cup-washer with a flexible lead at the low-voltage terminal. Both terminals are insulated from the case, one at rated voltage and the other at 400 volts d-c.

The new capacitors for radio transmitters, also in cylindrical cases, are available in ratings up to 2000 volts d-c. Approximately 2 inches in diameter, they range in length from 3 to 6½ inches. They are hermetically sealed and equipped with ceramic insulators and an adjustable clamp-type mounting bracket. See Bulletin GEA-3018.

## Phototube Relay

A NEW G-M Laboratories, Inc., Chicago, phototube relay is suitable for experimental or research work for educational problems or lecture demonstrations. Known as Type 1224A the unit comes with a wiring diagram in the base and is furnished as a kit for student assembly or completely assembled and ready for use.

## NOISE TESTED

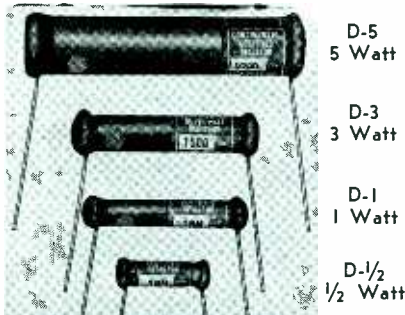

CONTINENTAL CARBON Ceramic Insulated D-type NOISE TESTED Carbon Resistors are universally used by the most critical experimenters and technicians in the communications and allied fields. Although they are slightly higher in cost than the ordinary type of carbon resistors, CONTINENTAL guarantees a noise response not exceeding 1/2 part in a 1000000, thus making them amply suitable in very high gain amplifier circuits, crystal microphone pick-ups, and all attenuation networks.

Try CONTINENTAL CARBON D-type Resistors in your next design.

### CONTINENTAL CARBON Inc.

13906 Lorain Ave., Cleveland, Ohio  
In Canada, Toronto, Ontario

RESISTORS, CONDENSERS, FILTERNOYS

## McGraw-Hill DIRECT MAIL LIST

As business paper publishers for over fifty years, McGraw-Hill is uniquely equipped to offer complete, authoritative direct mail coverage of industry's major markets. Extreme accuracy is maintained (guaranteed to 98%) and through careful analysis of markets, complete classification of companies and personnel, etc., the widest possible selections are available. Send for handy reference folder, "Hundreds of Thousands of Reasons Why" which describes how McGraw-Hill Lists are built and maintained.

### What Fields Do You Want to Reach?

Aviation  
Bus & Electric Railways  
Civil Engineering and Construction  
Administrative Executives

Electrical Dealers & Wholesalers  
Mill Supply Houses  
Power Services  
Product Engineering & Design  
Production and Maintenance  
Radio Dealers & Wholesalers  
Radio Engineering & Design

For further details, selections from above basic classifications, counts, prices, etc., or estimates on special lists . . . ask any representative or write to



Complete Lists Covering Industry's Major Markets



## Tube Shields

GOAT RADIO Tube Parts, Inc., Brooklyn, has announced a new line of tube shields to fit the new 1.4 volt, low drain, 50 ma. series of battery tubes. Also a new series of tube shields for the Bantam Tubes now offered by several radio tube manufacturers. Samples and literature are available.

## Resistors

A SERIES of wire-wound resistors in 5, 10 and 20 watts size are announced by Continental Carbon, Inc., Cleveland, Ohio. A low temperature coefficient wire wound on porcelain tubes with copper leads makes up the essential elements of these units.

## Electrolytic Condenser

A COMPACT DRY condenser in a 1 in. diameter can, with simple ring mounting is announced by Aerovox Corp., Brooklyn, in single, double, and triple sections.

A more thorough means of testing condensers is provided in the new Aerovox condenser and resistance bridge. This instrument measures capacity from 100  $\mu\text{f}$  to 100  $\mu\text{f}$ , and power factor from 0 to 50%. It measures resistance values from 10 ohms to 1 megohm in 5 ranges and insulation resistance between 350 megohms to infinity at 500 volts and down to 10 megohms at lower voltage.

## Stable Condensers

SILVERED mica condensers have been announced by Aerovox. These fall into the category of the newer units which are remarkably free from capacity drift due to temperature or humidity changes.

## Bushing

A COMBINATION bushing and strain relief for cord sets has been developed by General Electric Co., Bridgeport, Conn. It is of particular interest to radio manufacturers because of the necessity of protecting sets against damage from insecure cords. It is unnecessary to tie knots as a measure of strain relief.

## 75 Watt Rheostat

A 75 WATT power rheostat-potentiometer is now made available by the Ohmite Manufacturing Company of Chicago.

The new Model "G" incorporates the outstanding features of the other Ohmite models. It has the protection of vitreous enamel which covers and separates the individual turns of wire, binding the entire assembly rigidly to the porcelain core—dissipates heat rapidly, and is mechanically strong.

The entire shaft and bushing assembly is insulated from the electrical circuit by a ceramic driving hub. The rheostat can be mounted directly upon metal panels without further insulation.

## Microdyne Pickup

A NEW COMPENSATED Microdyne can be purchased at the same price of ordinary pickups according to Audak Company, 500 Fifth Ave., New York City. By means of a new inductor and a newly developed low-pass filter, coupled within the pickup, the response is flat from 500 to 8,000 cycles and has a gradually rising characteristic from 500 cycles down, reaching about 12 db at 50 cycles.

## Sensitive Relay

TYPE 3-A relay is compact, sturdy and is an instrument of rapid, positive action at low power input according to Sigma Instruments, Inc., 388 Trapelo Rd., Belmont, Mass. It handles non-inductive loads up to 150 watts at 110 volts a.c., and requires only 12 milli-

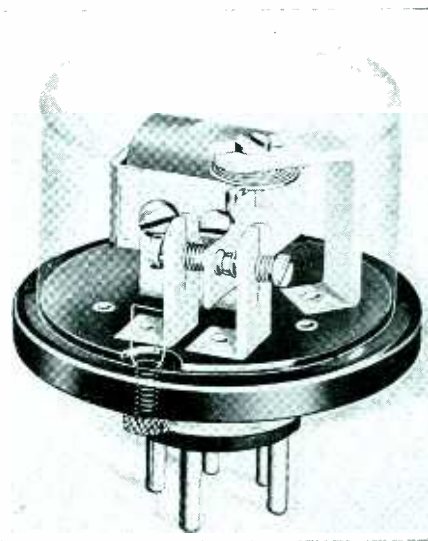

watts for its operation and can be installed directly in a variety of vacuum tube circuits. It is obtainable in various field resistances. Size is 2 $\frac{3}{8}$ x2 $\frac{1}{4}$  in. This instrument has essentially the same characteristics as the type 2-A but incorporates structural modifications.

## Fasteners

SEMS—a pre-assembled Shakeproof Lock Washer and standard machine screw—is the latest addition to Shakeproof's line of metal fastening products. This new assembly unit saves time and money by reducing labor costs, speeding up production and eliminating such waste as lost lock washers. Each screw is equipped with the correct size of lock washer for its particular type of head. As the lock washer cannot drop off, no screw can be applied without having a lock washer under the head. Tests in both large and small production plants indicate not only immediate cost savings, but faster and better production. Literature describing SEMS in detail available from Shakeproof Lock Washer Co., 2501 North Keeler Avenue, Chicago, Illinois.

# CHECK LIST

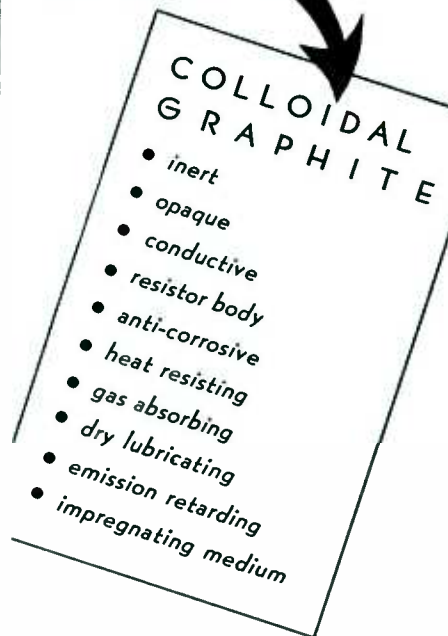

Research workers interested in the development of new electronic devices and the perfection of the old will find the manifold characteristics of "dag" colloidal graphite industrially valuable.

Being the result of a physico-chemical process of subdivision and dispersion, "dag" readily penetrates porous bodies and imparts to their surface qualities of lubricity, conductivity and coloring. In addition, "dag" provides tenacious films having heat, corrosion and chemical resisting properties.

Being an electrical conductor, such graphite layers form guard rings, focusing anodes, contacts, shielding deposits, electrodes and resistances. "Dag" is also low in photo-electric sensitivity, is radio inactive, diamagnetic, non-abrasive and highly pure.

We will be glad to cooperate by supplying samples and literature.

- PRODUCT SAMPLES
- CATHODE RAY TUBES
- VACUUM TUBES
- RESISTANCES



**ACHESON**  
COLLOIDS CORPORATION  
PORT HURON, MICHIGAN

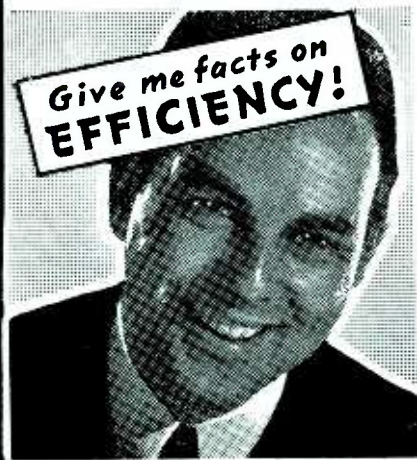

Give me facts on  
**EFFICIENCY!**

CHIEF ENGINEER

I must  
consider the  
**ECONOMY!**

GENERAL  
MANAGER



## —LINGO

### Vertical Tubular Steel Radiators give you both!

● Lingo Tube Radiators are designed and constructed to answer the demands of the "control room" for Efficiency and the "front office" requirements for Economy. No doubt, you are interested in both. If so, let us show and prove to you that Lingo Tube Radiators give within 3% of 100% efficiency! Let us explain how savings up to one-half have been effected by our single responsibility of constructing and erecting. These important factors combined with our 40 years of experience is your assurance that we can answer your antenna problem with maximum efficiency at a minimum of cost.

### Free!

Our completely detailed folder: "NEW STANDARDS FOR VERTICAL RADIATORS" will be gladly sent to interested station engineers and managers on request.



JOHN E. LINGO & SON, INC.  
Dept. E9, Camden, N. J.

# LINGO

## VERTICAL TUBULAR STEEL RADIATORS

### Program Controller

WHEREVER VARIABLE temperature control is required over any period of time a program control offered by Wheelco Instruments Co., 1933 S. Halsted St., Chicago, Ill. is available. This consists of a program unit and a controller mounted integrally. To the temperature control setting pointer of the Wheelco Capacitrol is attached an idler arm which rides on the edge of the contoured disk of the program unit. The temperature of a furnace may be controlled at any point set by the pointer. The disk can be cut to any time cycle desired with any variation of temperature control.

### Electronic Welding Contactor

FOR WELDING mild steel products and other readily-welded metals, a new "Weld-o-trol" electronic power switch for controlling the primary of welding transformers and suitable for use with existing timing devices, is announced by Westinghouse E. & M. Co., East Pittsburgh. With either sealed-off or continuously pumped ignitron tubes, the Weld-o-trol offers an instantaneous power switch for producing uniform welds, and is free of moving parts, arcing contacts and noise. Available ratings, are roughly equivalent to 300 and 600 ampere conventional welding contactors.

### Sound Distribution System

FOR SCHOOLS having 20 rooms or less, Model TES, Operadio Mfg. Co., St. Charles, Ill. Master control, unit amplifiers, ten loud speakers, ten speaker cabinets, microphone and stand are included in the unit. Each room can be talked to singly or all rooms simultaneously, and a radio set and high impedance phonograph unit can be used.

### Frequency Meter

SUPERCEDING Type 101 micrometer frequency meter the Lampkin Laboratories, Bradenton, Fla., have developed Type 103 which is especially suitable for transmitter checking in compliance with FCC requirements.

### Flux

A NON-CORROSIVE soldering flux for brass, tin, bronze and copper, designed primarily to meet the needs of fast soldering on a mass-production basis, is now being marketed by The Ohio Carbon Company, 12508 Berea Road, Cleveland, Ohio. It is stated to penetrate the joints thoroughly and quickly, and was originally evolved in the Company's laboratories for use on a specially difficult soldering problem in their own manufacturing processes where all commercial liquid soldering fluxes had been unsuccessful.

## Literature

(Continued from page 62)

**Rainbow Hued Acetate Materials.** Beautiful folder from Bakelite Corp., 247 Park Ave., N. Y., on colored Bakelite cellulose acetate molding materials.

**Police Radio.** Bulletin of data on police and fire, stationary and mobile equipment. Radio Engineering Laboratories, Inc., Long Island City, N. Y.

**Exact-duplicate Controls.** 4-page bulletin is handy numerical listing including corresponding standard controls. Clarostat Mfg. Co., 285 N. Sixth St., Brooklyn, N. Y.

**Fault Location in Cables.** Note book E-53-441, a 1938 sequel for linemen and trouble-shooters. Includes diagrams and capacitance tests. Leeds & Northrup Co., 4901 Stenton Ave., Philadelphia, Pa.

**Power Filters.** 4-page bulletin "Whisk Balancing and Semi-tuned Power Filters" for all power, ignition and antenna circuits. Whisk Laboratories, 145 W. 45th St., New York City.

**Rider Chanalyst.** Available for servicemen. 16-page booklet includes numerous diagrams, explanations, and illustrations of new test instrument. Service Instruments, Inc., 404 Fourth Ave., New York City.

**New Stock List.** No. 55-B lists thousands of washer specifications in various materials. For electronic equipment manufacturers. Wrought Washer Mfg. Co., 2100 S. Bay St., Milwaukee, Wis.

**Castings.** "Finishing of Zinc Alloy Die Castings and Rolled Zinc", The New Jersey Zinc Co., 160 Front St., New York, N. Y.

**Tube Alloys.** Loose-leaf data of practical engineering data on alloys used in the manufacture of electron tubes. Driver-Harris Co., Harrison, N. J.

**Transceivers.** Bulletins on duplex transmitter-receivers, power supply equipment, crystal controlled transmitters, pack transmitters, etc. Radio Transceiver Laboratories, Richmond Hill, N. Y.

**Transmitters.** Lists complete line for amateurs, commercial, and experimental communication service. Transmitter Equipment Mfg. Co., 130 Cedar St., New York City.

**Capacity and Resistance Bridge.** Manual gives practical instructions for miscellaneous application, also the theory and functioning. Price 50c. Aerovox Corp., 70 Washington St., Brooklyn, N. Y.



## New Products

### Sound Systems

MODEL FR60 is a 60 watt public address system of Webster-Company, Chicago, which incorporates a high speed expander, multi-stage degeneration, remote control and dual tone compensation.

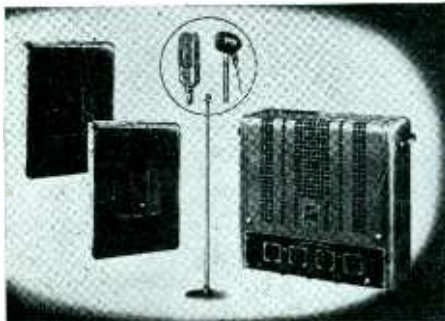

The amplifier is equipped with 4 input mixing circuits and has variable output connections. Besides the amplifier, this system is furnished with two P. M. speakers and either velocity or dynamic type microphone.

MODEL S-40 will handle any number of rooms up to 40 and is an enlarged and improved edition of the S-20. It is compact, centralized, completely self-contained and includes separate communication system which allows engaging in a two-way conversation simultaneously with the regular program. Programs can be picked up in any room and fed to any one or all other rooms. A 6-tube superheterodyne with push button tuner is included.

### 12 in. Speaker

FIVE MODELS of 12 in. permanent magnet speakers have been introduced by Jensen Radio Mfg. Co., Chicago. These speakers vary in sensitivity, power and capacity and response. They list from \$9.85 to \$34.75.

### Sound System

A DUAL CHANNEL remote control amplifier and sound system has been designed by Transformer Corp. of America (Clarrion). Full control of the two channels from any distance within hearing range of the system is obtained and no audio signal voltage is carried by the controlled circuit.

### Oscillator Doubler

THE "OD-10" crystal unit is intended to be used with other foundation units such as the "BD-40" and "PA-300". Combined, these three units constitute a 300-watt all-band transmitter of modern design. The "OD-10" can be used as a beginner's transmitter with outputs as high as 25 watts on two bands with a single crystal. The entire unit is self-supporting and fastens directly to a panel with four mounting screws. Hammarlund Mfg. Co., 424 W. 33rd St., New York.

## NOW READY

### new type "K" AIRCRAFT PLUGS



HERE is a new Bulletin from the Cannon Company filled with vital information on the latest developments in Cannon Cable Connectors. It describes a new, lightweight line of Plugs designed primarily for use in Aircraft radio, instrument and electrical circuits. Minimum weight and size, without sacrifice of mechanical ruggedness, are the keynote of this ultra-modern series . . . the result of many years of experience in the design and manufacture of multiple circuit disconnects for sound equipment and for Aircraft service.

The new series, one of several popular lines for Aircraft use, comprises seven diameter sizes and from 1 to 37 conductors . . . over 450 items, none of which are duplicates. When writing for descriptive matter on this new Aircraft Plug, just ask for "Bulletin K."

CANNON ELECTRIC DEVELOPMENT CO.

- ★ 420 West Avenue 33, Los Angeles, California
- ★ EASTERN SALES OFFICE, 220 Fifth Ave., New York, N.Y.

## CANNON PLUGS



# BAREX GETTERS

### SMALL—BUT IMPORTANT!

If tube performance had little dependence on the scavenging action of Getters we could hedge on the quality of Barex. However, the opposite is true. They are small, but mighty important. And because we make just this one product, Barex Embedded Getters have had the advantages of continued improvement and almost perfect laboratory control of manufacture . . . Better Getters! Made in a wide range of sizes, shapes and compositions.

KING LABORATORIES, INC.  
SYRACUSE, N. Y.



# RCA INSTRUMENTS DO A BIG JOB AT SMALL COST



**NEW RCA 2" CATHODE RAY OSCILLOGRAPH**... uses the RCA-902 2" cathode ray tube... Has new, easily-read, tilt-mounted screen. All controls on front panel. Amplifiers, both horizontal and vertical—gain 50—sensitivity 0.5 (RMS) per inch. Has built-in, saw-tooth oscillator. Stock No. 151-2. **Net Price \$49.95**



**RCA BEAT FREQUENCY AUDIO OSCILLATOR**... range—30 to 15,000 cycles. For testing loudspeakers, P.A. systems, etc. Three output impedances. Has large easily-read dial. Stock No. 154. **Net Price \$49.95**

*RCA presents the Magic Key every Sunday, 2 to 3 P.M., E. D. S. T., on the NBC Blue Network.*

Over 325,000,000 RCA radio tubes have been purchased by radio users... In tubes, as in parts and test equipment, it pays to go RCA All the Way.



**Parts**

**FOR PROFIT**

RCA Manufacturing Co., Inc., Camden, N. J.  
A Service of Radio Corporation of America



## ENCLOSED RELAYS

That Operate in Any Position

Available in Power, Vacuum Tube and Radio Frequency Types.

Especially adaptable for mobile, marine, aircraft and police installations. Size of relay illustrated 1 1/16" x 1 1/8" x 2 1/4".

**ALLIED CONTROL CO., INC.**  
95 Liberty St. New York, N. Y.

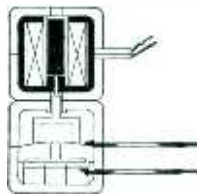

## NEW UNIVERSAL FULL FREQUENCY CUTTING HEAD



U. S. Patent No. 2005154

The PERFECT electrically, magnetically and mechanically balanced cutting head. Produces clear crisp recordings—brilliant highs and full bass. No rubber or substitutes, nothing to deteriorate. Guaranteed day in and day out for uninterrupted service every day for years. Records freq. 30 to 10,000 cycles and over. Impedance 15 ohms. Requires + 14 db. input level, 2 or 3 watts. Climatically sealed. For replacement or new installations.



**Universal Microphone Co., Ltd.**  
INGLEWOOD, CALIFORNIA, U.S.A.

EXPORT AGENTS - FRAZER & CO., 7 FRONT ST. SAN FRANCISCO

## Inter-Communication and Paging System

NEW REMLER Co., Ltd., San Francisco, Cal., 24-station apparatus permits two way conversation between master and any individual station or any group of outlying stations. It also permits paging of up to 24 stations simultaneously.

Phonograph, radio and microphone inputs are provided, making the system particularly desirable for schools and other institutional installations.

## Noise-suppressing Antenna System

A NOISE-SUPPRESSING all-wave antenna system at a popular price is announced by Technical Appliance Corp., 17 East 16 St., New York City. This antenna system efficiently handles both standard broadcast and short-wave signals. It comprises one long aerial, transformer unit, twisted-pair downlead, set coupler, and necessary accessories. Everything comes assembled, wired and soldered, and can be strung up in an hour or less, without tools or special skill. Model 600 lists at \$5.00.

## Sound Film Recorder

A NEW PROFESSIONAL 16 mm sound film recorder is introduced by Electrical Research Products, Inc., and announced by Western Electric Co., 195 Broadway, New York City. It has two immediate applications: Direct recordings may be made independently, and by electrically interlocking the machine with a 35 mm recorder both sizes of negative may be made simultaneously. It can also be used to re-record from existing 35 mm.

## Three Channel Electronic Mixer

QUITE DIFFERENT from the ordinary type of electronic mixer in which two or more plate circuits are connected over a common load resistor and coupled to an amplifier, a new Jefferson Electric Co., Bellwood, Ill., circuit overcomes the shunting effect on the load resistance of the tube actuated by the d-c plate resistance of the tubes not actuated. This shunting effect of the idle tubes decreases the load resistance network which performs in such manner as to keep the load resistance, acting on each individual tube, never lower than required for a minimum of distortion.

Individual volume controls are in the output circuits rather than in the grid circuits, where high resistance potentiometers would have to be used, not considering the fact that in changing sources the potentiometers would have to be changed to conform to their respective source impedances. The mixer is hum-free by thorough filtering of plate and "C" supplies.



# PROFESSIONAL SERVICES

(Rates on Application)

## ELECTRICAL TESTING LABORATORIES

Characteristics of Vacuum Tubes  
Tests of photo cells, glow lamps, crater lamps.  
Tests of electronic and optical devices.  
East End Avenue and 79th Street  
New York, N. Y.  
Phone: Butterfield 8-2600

## ELECTRONIC DEVELOPMENTS CORPORATION

Research and Development in Electronics and Radio Communication  
983 National Press Building  
Washington, D. C.

## INTERNATIONAL ELECTRONICS, INC.

AMERICAN CONSULTING ENGINEERS TO FOREIGN MANUFACTURERS  
Designs ..... Specifications  
Electrolytics ..... Tubes ..... Resistors  
Transmitters ..... Receivers  
630 Fifth Avenue New York, N. Y.  
Cable:—Interengin, New York

## HAROLD J. McCREARY

Mem. A.I.E.E. & W.S.E.  
Consulting Engineer  
Laboratory Facilities  
Research ..... Electronics  
Development ..... Television  
Design ..... Radio  
Factory Practice ..... Railroad Signaling  
Patent Studies ..... Telephony  
105 W. Adams St. Phone STAtE 4003 Chicago, Ill.

## RADIO DEVELOPMENT & RESEARCH CORP.

CONSULTANTS AND DESIGNERS  
including  
Amplifiers—Antennas—Transmitters  
Receivers—Laboratory Equipment  
Special equipment designed and constructed  
145 West 45th Street, New York, N. Y.  
Tel. BRyant 9-6808

## ROWE RADIO RESEARCH LABORATORY CO.

DOMESTIC SECTION  
Development Engineers of Radio Receivers  
Allied Apparatus and Components.  
Designers and Constructors of Special Equipment.  
Complete Laboratory Facilities.  
1103 Bryn Mawr Ave. Chicago, Illinois.  
Telephones—Longbeach 3163—3164

## ROWE RADIO RESEARCH LABORATORY CO.

FOREIGN SECTION  
Engineering Information Specialists and Consultants.  
Complete Laboratory at Disposal of Clients.  
Current Radio Receiver Characteristics Available.  
Sales, Patent and License Negotiation Intermediaries.  
1103 Bryn Mawr Ave. Chicago, Illinois, U.S.A.  
Cable Address—RORADLAB CHICAGO

## THE SOLUTION OF YOUR PROBLEM

in the field of Electronic devices may be found through enlisting the services of the Consultants whose cards appear on this page.

This is a highly specialized field and specialists are therefore better able to undertake the rapid developments necessary to keep in step with modern manufacturing progress.

## Cupaloy Castings

ENLISTED AS an ally of the ignitron tube in making possible continuous welds for use in construction of high-vacuum thermionic tubes for radio sets is the new product to come out of the Westinghouse laboratory. By a process of juggling atoms, Cupaloy comes close to being pure copper with steel strength. For welding tips, it has shown a service life several times greater than pure copper and from 50 to 200% longer than that of other low resistance alloys.

## Voltmeter

A NEW INSTRUMENT Model 4900-S measures d-c volts by means of a potentiometer. A built-in power supply, furnishes the balancing voltage. The instrument takes no current from the source being measured up to 250 volts d-c. Five ranges of resistance cover from .05 ohms to 10 megohms. Hickok Electrical Instrument Co., Cleveland, O.

An impressive assembly of servicing equipment has been called the Show Lab by Hickok. It is designed to be a useful set of tools as well as to aid the dealer and serviceman to merchandise the service they are to offer.

## Electrostatic Voltmeter

FOR MEASUREMENTS of a-c or d-c voltage on grounded systems. Available from General Electric Co., the instrument is available in ratings of 3, 5, 10, 15 and 20 kv and is designed for fast response and ability to hold its calibration.

G.E. also announces temperature-compensated instruments for reducing temperature errors over a wide range of condition. Ratings are 150 and 150/300 volts.

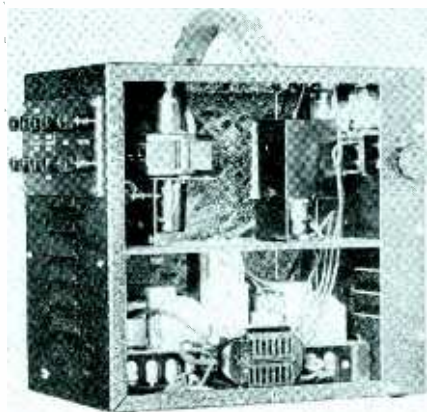

Another new G.E. product is a portable photoelectric contact-making galvanometer for factory or laboratory, for permanent or temporary installations, for use with bridges or other apparatus requiring an external galvanometer. One application is in the field of temperature measurement and control. Sensitivity of 2.2 microvolts per division is obtainable.

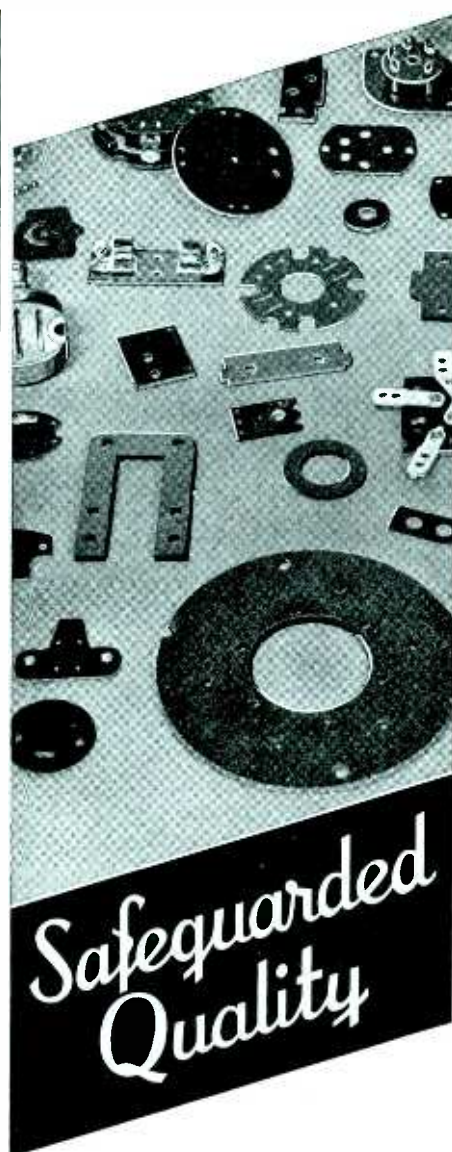

Safeguarded Quality

# INSUROK

THE SUPERIOR PLASTIC

SO constant and searching is the guardianship of quality, workmanship and precision in the Richardson plants, that every part or finished product must measure up to the most exacting standards of excellence. Watchful, alert, comprehensive inspection throughout manufacture, packing and shipping insure superiority of all INSUROK molded and laminated parts. That, in turn, means manufacturing economies for you, increased value to your products.

The RICHARDSON COMPANY  
MELROSE PARK, CHICAGO, ILL. PHONES 1008 1009 1010 1011 1012 1013 1014 1015 1016 1017 1018 1019 1020 1021 1022 1023 1024 1025 1026 1027 1028 1029 1030 1031 1032 1033 1034 1035 1036 1037 1038 1039 1040 1041 1042 1043 1044 1045 1046 1047 1048 1049 1050 1051 1052 1053 1054 1055 1056 1057 1058 1059 1060 1061 1062 1063 1064 1065 1066 1067 1068 1069 1070 1071 1072 1073 1074 1075 1076 1077 1078 1079 1080 1081 1082 1083 1084 1085 1086 1087 1088 1089 1090 1091 1092 1093 1094 1095 1096 1097 1098 1099 1100 1101 1102 1103 1104 1105 1106 1107 1108 1109 1110 1111 1112 1113 1114 1115 1116 1117 1118 1119 1120 1121 1122 1123 1124 1125 1126 1127 1128 1129 1130 1131 1132 1133 1134 1135 1136 1137 1138 1139 1140 1141 1142 1143 1144 1145 1146 1147 1148 1149 1150 1151 1152 1153 1154 1155 1156 1157 1158 1159 1160 1161 1162 1163 1164 1165 1166 1167 1168 1169 1170 1171 1172 1173 1174 1175 1176 1177 1178 1179 1180 1181 1182 1183 1184 1185 1186 1187 1188 1189 1190 1191 1192 1193 1194 1195 1196 1197 1198 1199 1200 1201 1202 1203 1204 1205 1206 1207 1208 1209 1210 1211 1212 1213 1214 1215 1216 1217 1218 1219 1220 1221 1222 1223 1224 1225 1226 1227 1228 1229 1230 1231 1232 1233 1234 1235 1236 1237 1238 1239 1240 1241 1242 1243 1244 1245 1246 1247 1248 1249 1250 1251 1252 1253 1254 1255 1256 1257 1258 1259 1260 1261 1262 1263 1264 1265 1266 1267 1268 1269 1270 1271 1272 1273 1274 1275 1276 1277 1278 1279 1280 1281 1282 1283 1284 1285 1286 1287 1288 1289 1290 1291 1292 1293 1294 1295 1296 1297 1298 1299 1300 1301 1302 1303 1304 1305 1306 1307 1308 1309 1310 1311 1312 1313 1314 1315 1316 1317 1318 1319 1320 1321 1322 1323 1324 1325 1326 1327 1328 1329 1330 1331 1332 1333 1334 1335 1336 1337 1338 1339 1340 1341 1342 1343 1344 1345 1346 1347 1348 1349 1350 1351 1352 1353 1354 1355 1356 1357 1358 1359 1360 1361 1362 1363 1364 1365 1366 1367 1368 1369 1370 1371 1372 1373 1374 1375 1376 1377 1378 1379 1380 1381 1382 1383 1384 1385 1386 1387 1388 1389 1390 1391 1392 1393 1394 1395 1396 1397 1398 1399 1400 1401 1402 1403 1404 1405 1406 1407 1408 1409 1410 1411 1412 1413 1414 1415 1416 1417 1418 1419 1420 1421 1422 1423 1424 1425 1426 1427 1428 1429 1430 1431 1432 1433 1434 1435 1436 1437 1438 1439 1440 1441 1442 1443 1444 1445 1446 1447 1448 1449 1450 1451 1452 1453 1454 1455 1456 1457 1458 1459 1460 1461 1462 1463 1464 1465 1466 1467 1468 1469 1470 1471 1472 1473 1474 1475 1476 1477 1478 1479 1480 1481 1482 1483 1484 1485 1486 1487 1488 1489 1490 1491 1492 1493 1494 1495 1496 1497 1498 1499 1500 1501 1502 1503 1504 1505 1506 1507 1508 1509 1510 1511 1512 1513 1514 1515 1516 1517 1518 1519 1520 1521 1522 1523 1524 1525 1526 1527 1528 1529 1530 1531 1532 1533 1534 1535 1536 1537 1538 1539 1540 1541 1542 1543 1544 1545 1546 1547 1548 1549 1550 1551 1552 1553 1554 1555 1556 1557 1558 1559 1560 1561 1562 1563 1564 1565 1566 1567 1568 1569 1570 1571 1572 1573 1574 1575 1576 1577 1578 1579 1580 1581 1582 1583 1584 1585 1586 1587 1588 1589 1590 1591 1592 1593 1594 1595 1596 1597 1598 1599 1600 1601 1602 1603 1604 1605 1606 1607 1608 1609 1610 1611 1612 1613 1614 1615 1616 1617 1618 1619 1620 1621 1622 1623 1624 1625 1626 1627 1628 1629 1630 1631 1632 1633 1634 1635 1636 1637 1638 1639 1640 1641 1642 1643 1644 1645 1646 1647 1648 1649 1650 1651 1652 1653 1654 1655 1656 1657 1658 1659 1660 1661 1662 1663 1664 1665 1666 1667 1668 1669 1670 1671 1672 1673 1674 1675 1676 1677 1678 1679 1680 1681 1682 1683 1684 1685 1686 1687 1688 1689 1690 1691 1692 1693 1694 1695 1696 1697 1698 1699 1700 1701 1702 1703 1704 1705 1706 1707 1708 1709 1710 1711 1712 1713 1714 1715 1716 1717 1718 1719 1720 1721 1722 1723 1724 1725 1726 1727 1728 1729 1730 1731 1732 1733 1734 1735 1736 1737 1738 1739 1740 1741 1742 1743 1744 1745 1746 1747 1748 1749 1750 1751 1752 1753 1754 1755 1756 1757 1758 1759 1760 1761 1762 1763 1764 1765 1766 1767 1768 1769 1770 1771 1772 1773 1774 1775 1776 1777 1778 1779 1780 1781 1782 1783 1784 1785 1786 1787 1788 1789 1790 1791 1792 1793 1794 1795 1796 1797 1798 1799 1800 1801 1802 1803 1804 1805 1806 1807 1808 1809 1810 1811 1812 1813 1814 1815 1816 1817 1818 1819 1820 1821 1822 1823 1824 1825 1826 1827 1828 1829 1830 1831 1832 1833 1834 1835 1836 1837 1838 1839 1840 1841 1842 1843 1844 1845 1846 1847 1848 1849 1850 1851 1852 1853 1854 1855 1856 1857 1858 1859 1860 1861 1862 1863 1864 1865 1866 1867 1868 1869 1870 1871 1872 1873 1874 1875 1876 1877 1878 1879 1880 1881 1882 1883 1884 1885 1886 1887 1888 1889 1890 1891 1892 1893 1894 1895 1896 1897 1898 1899 1900 1901 1902 1903 1904 1905 1906 1907 1908 1909 1910 1911 1912 1913 1914 1915 1916 1917 1918 1919 1920 1921 1922 1923 1924 1925 1926 1927 1928 1929 1930 1931 1932 1933 1934 1935 1936 1937 1938 1939 1940 1941 1942 1943 1944 1945 1946 1947 1948 1949 1950 1951 1952 1953 1954 1955 1956 1957 1958 1959 1960 1961 1962 1963 1964 1965 1966 1967 1968 1969 1970 1971 1972 1973 1974 1975 1976 1977 1978 1979 1980 1981 1982 1983 1984 1985 1986 1987 1988 1989 1990 1991 1992 1993 1994 1995 1996 1997 1998 1999 2000 2001 2002 2003 2004 2005 2006 2007 2008 2009 2010 2011 2012 2013 2014 2015 2016 2017 2018 2019 2020 2021 2022 2023 2024 2025 2026 2027 2028 2029 2030 2031 2032 2033 2034 2035 2036 2037 2038 2039 2040 2041 2042 2043 2044 2045 2046 2047 2048 2049 2050 2051 2052 2053 2054 2055 2056 2057 2058 2059 2060 2061 2062 2063 2064 2065 2066 2067 2068 2069 2070 2071 2072 2073 2074 2075 2076 2077 2078 2079 2080 2081 2082 2083 2084 2085 2086 2087 2088 2089 2090 2091 2092 2093 2094 2095 2096 2097 2098 2099 2100 2101 2102 2103 2104 2105 2106 2107 2108 2109 2110 2111 2112 2113 2114 2115 2116 2117 2118 2119 2120 2121 2122 2123 2124 2125 2126 2127 2128 2129 2130 2131 2132 2133 2134 2135 2136 2137 2138 2139 2140 2141 2142 2143 2144 2145 2146 2147 2148 2149 2150 2151 2152 2153 2154 2155 2156 2157 2158 2159 2160 2161 2162 2163 2164 2165 2166 2167 2168 2169 2170 2171 2172 2173 2174 2175 2176 2177 2178 2179 2180 2181 2182 2183 2184 2185 2186 2187 2188 2189 2190 2191 2192 2193 2194 2195 2196 2197 2198 2199 2200 2201 2202 2203 2204 2205 2206 2207 2208 2209 2210 2211 2212 2213 2214 2215 2216 2217 2218 2219 2220 2221 2222 2223 2224 2225 2226 2227 2228 2229 2230 2231 2232 2233 2234 2235 2236 2237 2238 2239 2240 2241 2242 2243 2244 2245 2246 2247 2248 2249 2250 2251 2252 2253 2254 2255 2256 2257 2258 2259 2260 2261 2262 2263 2264 2265 2266 2267 2268 2269 2270 2271 2272 2273 2274 2275 2276 2277 2278 2279 2280 2281 2282 2283 2284 2285 2286 2287 2288 2289 2290 2291 2292 2293 2294 2295 2296 2297 2298 2299 2300 2301 2302 2303 2304 2305 2306 2307 2308 2309 2310 2311 2312 2313 2314 2315 2316 2317 2318 2319 2320 2321 2322 2323 2324 2325 2326 2327 2328 2329 2330 2331 2332 2333 2334 2335 2336 2337 2338 2339 2340 2341 2342 2343 2344 2345 2346 2347 2348 2349 2350 2351 2352 2353 2354 2355 2356 2357 2358 2359 2360 2361 2362 2363 2364 2365 2366 2367 2368 2369 2370 2371 2372 2373 2374 2375 2376 2377 2378 2379 2380 2381 2382 2383 2384 2385 2386 2387 2388 2389 2390 2391 2392 2393 2394 2395 2396 2397 2398 2399 2400 2401 2402 2403 2404 2405 2406 2407 2408 2409 2410 2411 2412 2413 2414 2415 2416 2417 2418 2419 2420 2421 2422 2423 2424 2425 2426 2427 2428 2429 2430 2431 2432 2433 2434 2435 2436 2437 2438 2439 2440 2441 2442 2443 2444 2445 2446 2447 2448 2449 2450 2451 2452 2453 2454 2455 2456 2457 2458 2459 2460 2461 2462 2463 2464 2465 2466 2467 2468 2469 2470 2471 2472 2473 2474 2475 2476 2477 2478 2479 2480 2481 2482 2483 2484 2485 2486 2487 2488 2489 2490 2491 2492 2493 2494 2495 2496 2497 2498 2499 2500 2501 2502 2503 2504 2505 2506 2507 2508 2509 2510 2511 2512 2513 2514 2515 2516 2517 2518 2519 2520 2521 2522 2523 2524 2525 2526 2527 2528 2529 2530 2531 2532 2533 2534 2535 2536 2537 2538 2539 2540 2541 2542 2543 2544 2545 2546 2547 2548 2549 2550 2551 2552 2553 2554 2555 2556 2557 2558 2559 2560 2561 2562 2563 2564 2565 2566 2567 2568 2569 2570 2571 2572 2573 2574 2575 2576 2577 2578 2579 2580 2581 2582 2583 2584 2585 2586 2587 2588 2589 2590 2591 2592 2593 2594 2595 2596 2597 2598 2599 2600 2601 2602 2603 2604 2605 2606 2607 2608 2609 2610 2611 2612 2613 2614 2615 2616 2617 2618 2619 2620 2621 2622 2623 2624 2625 2626 2627 2628 2629 2630 2631 2632 2633 2634 2635 2636 2637 2638 2639 2640 2641 2642 2643 2644 2645 2646 2647 2648 2649 2650 2651 2652 2653 2654 2655 2656 2657 2658 2659 2660 2661 2662 2663 2664 2665 2666 2667 2668 2669 2670 2671 2672 2673 2674 2675 2676 2677 2678 2679 2680 2681 2682 2683 2684 2685 2686 2687 2688 2689 2690 2691 2692 2693 2694 2695 2696 2697 2698 2699 2700 2701 2702 2703 2704 2705 2706 2707 2708 2709 2710 2711 2712 2713 2714 2715 2716 2717 2718 2719 2720 2721 2722 2723 2724 2725 2726 2727 2728 2729 2730 2731 2732 2733 2734 2735 2736 2737 2738 2739 2740 2741 2742 2743 2744 2745 2746 2747 2748 2749 2750 2751 2752 2753 2754 2755 2756 2757 2758 2759 2760 2761 2762 2763 2764 2765 2766 2767 2768 2769 2770 2771 2772 2773 2774 2775 2776 2777 2778 2779 2780 2781 2782 2783 2784 2785 2786 2787 2788 2789 2790 2791 2792 2793 2794 2795 2796 2797 2798 2799 2800 2801 2802 2803 2804 2805 2806 2807 2808 2809 2810 2811 2812 2813 2814 2815 2816 2817 2818 2819 2820 2821 2822 2823 2824 2825 2826 2827 2828 2829 2830 2831 2832 2833 2834 2835 2836 2837 2838 2839 2840 2841 2842 2843 2844 2845 2846 2847 2848 2849 2850 2851 2852 2853 2854 2855 2856 2857 2858 2859 2860 2861 2862 2863 2864 2865 2866 2867 2868 2869 2870 2871 2872 2873 2874 2875 2876 2877 2878 2879 2880 2881 2882 2883 2884 2885 2886 2887 2888 2889 2890 2891 2892 2893 2894 2895 2896 2897 2898 2899 2900 2901 2902 2903 2904 2905 2906 2907 2908 2909 2910 2911 2912 2913 2914 2915 2916 2917 2918 2919 2920 2921 2922 2923 2924 2925 2926 2927 2928 2929 2930 2931 2932 2933 2934 2935 2936 2937 2938 2939 2940 2941 2942 2943 2944 2945 2946 2947 2948 2949 2950 2951 2952 2953 2954 2955 2956 2957 2958 2959 2960 2961 2962 2963 2964 2965 2966 2967 2968 2969 2970 2971 2972 2973 2974 2975 2976 2977 2978 2979 2980 2981 2982 2983 2984 2985 2986 2987 2988 2989

# DUMONT



## Largest Manufacturers of SILVERED MICA CONDENSERS

(Patent Pending)

There is a good reason why Dumont outsells any other make of silvered mica condensers. Production increased 6000% in six months time. No other make can show such growth. It had to be *SUPERIOR IN QUALITY* in order to get this acceptance.

- Extremely fine power factor.
- Unaffected by moisture.
- Non-microphonic.
- Excellent drift control.
- The most stable condenser.
- Constant spring contact.

**DUMONT ELEC. CO.** 514-516 Broadway, New York, U.S.A.  
Phone: CAnal 6-7980



## This New "EVEN SPEED" PHONOGRAPH MOTOR

- The new Alliance Self-starting "Even Speed" motor maintains proper record speed without the need of a governor, regardless of variations in record drag, line voltage or operating temperature.

Large bearings with ample oil reserves and laminated bakelite helical cut gears assure smooth, silent operation and long life. Motor design allows free ventilation and cooler operation. Motor dimensions are: Length 4-7/16"; Width 3/4"; Depth to bottom of motor board—2-13/16"; bottom of motor to top of spindle 4-11/32". Turn-table and motor (110 volt—60 cycle) furnished complete with rubber spools for mounting. Available with 9"-10" or 12" turn-tables.

For full information and prices write

**ALLIANCE MANUFACTURING CO.**  
Alliance, O.

## MICROHM WIRE WOUND RESISTORS

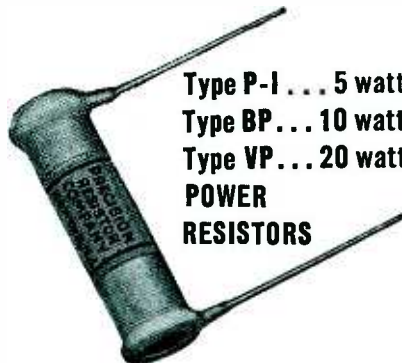

Type P-1 ... 5 watt  
Type BP ... 10 watt  
Type VP ... 20 watt  
**POWER  
RESISTORS**

### HIGH IN QUALITY

- ACCURATE ● COMPACT ●  
ECONOMICAL

Adaptable to applications such as public address amplifiers, midget, auto, and airplane radio sets, replacements or wherever low price, without sacrifice of quality and accuracy is required. Enamel wire wound; coated with ceramic insulation and baked at low temperatures; terminals hard soldered to windings. Accuracy to 2%; can be supplied in 1% accuracies at slight additional cost. Write for prices and details.

**PRECISION RESISTOR CO.**  
332 Badger Avenue  
NEWARK NEW JERSEY

## Field Intensity Meter

PORTABLE, LIGHT, fully self-contained and ruggedly constructed is this new product of Federal Telegraph Co., Newark, N. J. Single control tuning and a minimum of controls simplify operation. A single switch changes the built-in coils at will. No plug-in coils nor thermocouples are used.

## Plate Transformer

A NEW PLATE transformer was announced by Jefferson Electric Co., designed for operation from either 115 volt 60 cycle primary, or from 6 volt d-c for operation in conjunction with a vibrator unit. This transformer, No. 465-301, delivers 300 volts d-c at 100 ma from either 115 volt 60 cycle or 6 volt d-c primary supply. The 6 volt primary is tapped to supply heater voltage for a rectifier unit when the 110 volt primary is used. This transformer is assembled in sturdy black enameled housings of upright type with secondary leads out of bottom.

## Pickup

AN INDUCTOR type of unit with 1½ ounce needle pressure and wide in frequency response is available from Bruno Laboratories, New York. In this unit the needle is the armature and it may be changed easily. The output is high, equalling that of a modern microphone. To avoid resonance and to silence the pickup, the inertia of the arm has been increased by making it out of non-resonant alloy. It is acoustically compensated by electrical rather than mechanical means. This new Bruno unit is known as the Symphonic.

## Speed Nuts

THE SPEED NUT System of Tinnerman Stove & Range Co., Fulton Road, Cleveland, O., is an aid in assembly problems because of its spring tension fastening. It eliminates conventional nuts and lock washers, affords a firmer and better fastening means, and reduces assembly time and costs. 250 specific shapes and sizes are available for specific applications. Bulletins are available.

## Electrolytic Capacitors

DESIGNED for motor-starting and other a-c applications, the Cornell-Dubilier, South Plainfield, N. J., Type ETN dry electrolytic capacitors are hermetically sealed in small aluminum cans and are externally insulated with an impregnated fibre sleeve or container. Low power-factor and freedom from internal corrosion are their important qualities.

These capacitors have been designed for operation involving a maximum of 20 starts per hour, each start of 3 seconds duration. They are especially suited for use with fractional horsepower motors.



## Pilot Light Assembly

A 1 IN. PILOT light assembly is being manufactured by Dial Light Co. of Amer., 136 Liberty St., New York. This Model 100 uses Mazda S6 lamp removable from front of assembly. It can be furnished with smooth or faceted jewels and comes in 5 colors. Catalog is available.

## pH Meter

A NEW LINE of instruments for automatic pH recording and control with the glass electrode is announced by Coleman Electric Co., 310 Madison St., Maywood, Ill. A hermetically sealed amplifier is an integral part of the device. It will measure pH to approximately 0.02.

## Lifter

A PRACTICAL and durable device to prevent accident to fingers or hands of operators. May be used to lift feed and position metal blanks in stamping machines and die press operations. Industrial Products Co., 756 W. Somerset St., Philadelphia.

## Microphone

A "ROUND-THE-NECK" microphone for those who must move around and cannot be bothered with holding a microphone in a proper position. This is a crystal microphone and the output is considerably greater than that obtainable from a lapel mike or a hand mike. Sundt Engineering Co., 4238 Lincoln Ave., Chicago.

# U. S. PATENTS

## Electron Tube Applications

**Engine indicator.** An indicator for observing pressure variations by means of a cathode ray oscillograph. No. 2,113,376. Nathan Janco, Houston, Tex. See also No. 2,085,203 on a means for examining a series of cycles of events wherein pressure varies in repetitious manner. C. H. Schlesman, Socony Vacuum Oil Co.; No. 2,067,256, W. P. Brush, San Francisco, on an ignition testing system comprising electron tubes; and No. 2,117,141 on a vehicle electric power supply system using rectifiers. Carl Breer and G. C. Goode, Chrysler Corp.

**Measuring equipment.** Several patents to the Bailey Meter Co. on methods of measuring rate of flow, etc. No. 2,080,789, No. 2,109,222, and No. 2,112,682 to John D. Ryder; and No. 2,112,683 to R. E. Woolley.

**Flaw detector.** Patents on detecting flaws in metallic bodies. No. 2,109,455 to W. C. Barnes and H. W. Keevil, Highland Park, Ill., and No. 2,113,783 and 2,113,785 to the Sperry Products, Inc.

**Ion concentration.** Method for continuous measurement of hydrogen ion concentration of solutions. E. D. Doyle and G. A. Perley, Leeds & Northrup Co. No. 2,108,294. See also No. 2,058,761 to A. O. Beckman and H. E. Fracker, National Technical Laboratories, Pasadena, on an apparatus for testing acidity.

**Welding equipment.** Patents relating to the control of welding voltages or time. No. 2,045,801 and No. 2,045,803 to Walther Richter, A. O. Smith Corp.; No. 2,071,773 to Watson Sidney, RCA; and No. 2,085,696 to D. V. Edwards, Montclair, N. J.; also No. 2,054,343 to

David Sciaky, Paris, France, and No. 2,111,014, E. H. Vedder, Westinghouse.

**Transient measurement.** The method for the determination of electrical properties of matter for geophysical prospecting. No. 2,113,749. L. Statham, Standard Oil Development Co.

**Light meter.** A device for indicating the intensity of ultraviolet rays comprising a piece of fluorescent glass transparent to visible and long ultraviolet radiations and opaque to radiations below 3200 Angstrom units, light sensitive surfaces, etc. L. F. Bird, the Hanovaia Chemical & Mfg. Co. No. 2,114,163.

**Watch testing.** Method of recording the rate of a watch by picking up the sound of watch ticks, amplifying them, comparing them on a chronograph with the ticks from a standard watch. R. H.

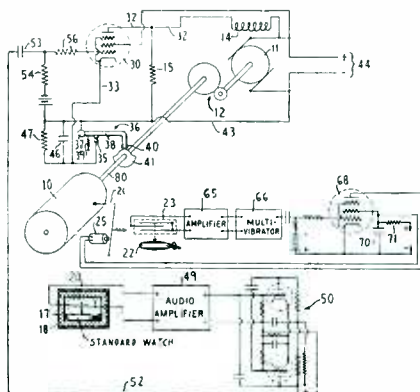

Caldwell and V. T. Braman, the Bulova Watch Co. No. 2,113,825.

**Measuring equipment.** Two patents to the Leeds & Northrup Co., Philadelphia. No. 2,113,164 and No. 2,113,436.

**"PINCOR"**  
**SILVER BAND**  
**DYNAMOTORS**



**Now.. Choose**  
**the Unit that**  
**Fits the Job..**

★ "PINCOR" offers the only complete line of "B" power supply equipment for police units, aircraft and radio broadcast service and sound systems. Available in a wide range of frames, sizes and capacities to fit any particular requirement.

★ "PINCOR" dynamotors are the last word in efficiency and regulation. Deliver high voltage current for proper operation of your apparatus with a minimum of A.C. ripple. These units will give years of smooth, quiet, satisfactory service. They are compact, light weight. Available with or without filter.

### NEW CATALOGUE FREE

Send for the latest "PINCOR" dynamotor catalogue and data sheets which includes description of the new types, "PS," "CS," and "TS" dynamotors. Mail coupon below.

### PIONEER GEN-E-MOTOR CORPORATION

466 W. SUPERIOR ST., CHICAGO, ILL.  
Export Address: 25 Warren St., N. Y., N. Y.  
Cable: Simontrice, New York



Send for  
**FREE**  
Copy!

Mail Coupon  
Today

PIONEER GEN-E-MOTOR CORPORATION  
Dept. R-41, 466 West Superior Street, Chicago, Illinois  
Without obligation kindly send me "PINCOR" Silver Band Dynamotor catalogue and data sheets.

Name .....  
Address .....  
City ..... State .....

# STABILIZED VOLTAGE



**RAYTHEON VOLTAGE REGULATORS**  
U. S. Patents 1,985,634 and 1,985,635

are magnetic devices without moving parts or adjustments. Manufactured since 1927. Regular users include Bell Laboratories, Federal Telegraph, General Electric, Radio Corporation, and Western Union.

INPUT—95-130 volts, 60 cycles, single-phase AC  
OUTPUT—115 volts ± 1% at all loads within ratings  
STOCK MODELS—60, 120, 250, 500 watts

**RAYTHEON MFG. CO.**  
WALTHAM, MASS.

**Strike indicator.** A photoelectric method of determining in a baseball

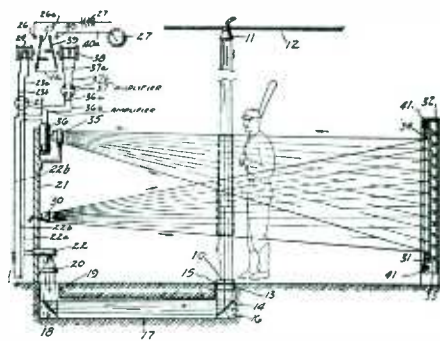

game whether a pitched ball is a strike or not. John Oram, Dallas, Tex. No. 2,113,899.

**Prospecting.** Method of determining the character of subterranean formation adjacent to a bore hole. R. W. Lohman, the Elliott Core Drilling Co. No. 2,114,056.

**Impedance measurement.** Method of testing phase differences due to the impedance property in human individuals. Samuel Bagno, New York, N. Y. No. 2,111,135.

**Control system.** System for continuously measuring the capacity of a con-

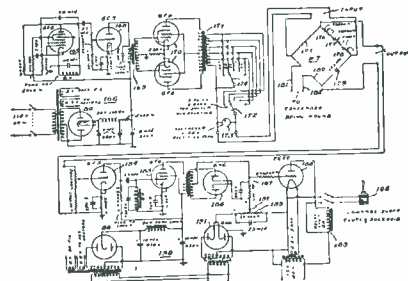

denser during its winding operation. R. W. Knight, RCA. No. 2,111,786.

**Printing.** Apparatus for making half-tone printing plates or engravings, comprising means to scan a picture, translating the picture shadings into electrical pulsations, an oscillator having a resonant circuit actuated by electrical pulsations to produce a varying frequency, amplifying the variation in frequency, and applying it to an engraving machine. A. Brimberg, Brooklyn, N. Y. No. 2,112,010.

**Aircraft indicator.** A cathode ray type of pitch and bank indicator. S. H. Anderson, Fort Monmouth, N. J. No. 2,114,283.

**Frequency meter.** An electron tube device. F. V. Hunt, General Radio Co. No. 2,119,389.

**Potential measurement.** Determining the value of potentials by automatic opposition by energizing by illumination a phototube to produce a voltage and current without auxiliary electromotive force, connecting the unknown potential in opposition to the photo-

## ACOUSTIC SWITCH

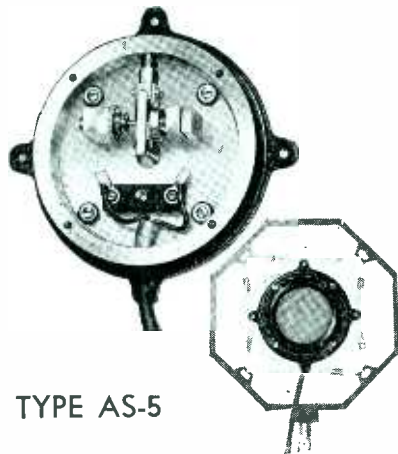

TYPE AS-5

SIMPLIFIES control circuits in which sound initiates electrical or mechanical actions.

- Especially applicable to use with
- door openers
  - traffic counters
  - production counters
  - chronoscope controls

Complete information on request.

**SIGMA INSTRUMENTS, Inc.**  
388 Trapelo Road  
BELMONT MASSACHUSETTS

## PLUGS — SOCKETS TERMINAL PANELS, ETC.



ILLUSTRATED  
PLUG: P-6-CCT—SOCKET: S-6-AB

HUNDREDS OF STANDARD ITEMS OR SPECIALS TO YOUR BLUE-PRINTS.

WRITE FOR BULLETINS.  
**HOWARD B. JONES**  
2300 Wabansia Avenue  
CHICAGO ILL.



tube and actuating by the current resulting from this connection an electromagnetically movable coil. Peter Wulff, Munich. No. 2,119,374.

**Unbalance determination.** Method of determining the unbalance of a rotatable body consisting in generating two a-c voltages of the same frequency, one voltage being derived from the unbalanced forces in the body, impressing this voltage on the grid of a tube

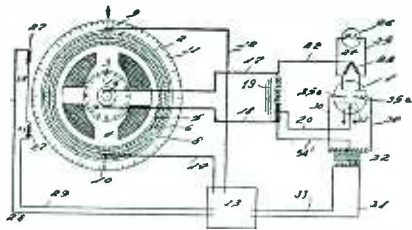

and impressing the second voltage on the plate and a smaller amount of the second voltage on a grid but with 180 deg. phase difference. The d-c current in the plate circuit is measured. This is a function of the first a-c voltage and its phase relation to the second a-c voltage to determine the angle and amount of unbalance in the rotatable body. Jens Sivertsen. Tinius Olsen Testing Machine Co. No. 2,118,770.

## PATENT SUITS

1,951,695, H. A. Wheeler, Peak detector; 2,041,273, same, Amplifier volume control, D. C. Del., Doc. E 1192, *Hazeltine Corp. v. R. C. A. et al.* Consent decree dismissing bill without prejudice Dec. 17, 1937.

2,047,863, W. G. Finch, Telecommunications system; 2,048,604, same, Electromagnetic coupling device; 2,066,463, same, Electrstatic telecommunication system, filed Nov. 23, 1937, D. C. Del., Doc. E 1230, *W. G. Finch v. International Research Laboratories, Inc., et al.*

1,573,374, P. A. Chamberlain; 1,707,617, 1,795,214, E. W. Kellogg; 1,728,879, Rice & Kellogg; 1,894,197, same; 2,052,316, R. E. Sagle, Variable condenser, D. C., S. D. Calif. (Los Angeles), Doc. E 1280-M, *R. C. A. et al v. L. Lowenstein (Low Radio Co.)*. Consent decree for plaintiffs holding patents valid and infringed; injunction Dec. 29, 1937.

1,403,475, H. D. Arnold; 1,403,932, R. H. Wilson; 1,507,016, L. de Forest; 1,507,017, same; 1,618,017, F. Lowenstein; 1,702,833, W. S. Lemmon; 1,811,095, H. J. Round; Re. 18,579, Ballantine & Hull, D. C., S. D. Calif. (Los Angeles), Doc. E 1279-J, *R. C. A. et al v. L. Lowenstein (Low Radio Co.)*. Consent decree for plaintiffs holding patents valid and infringed Dec. 29, 1937.

1,707,545, 1,992,268, E. C. Wente, Acoustic device; 1,730,425, H. C. Harrison, same; 1,734,624, same, Piston diaphragm having tangential corrugations; 2,037,187, same, Sound translating device, filed Dec. 29, 1937, D. C., S. D. Calif. (Los Angeles), Doc. 1308-Y, *Western Electric Co., Inc. v. Lansing Mfg. Co.*

# UNIVERSAL GAIN SET

A universal gain measuring instrument for rapid and accurate measurement of overall gain, frequency response, and power output of audio amplifiers.

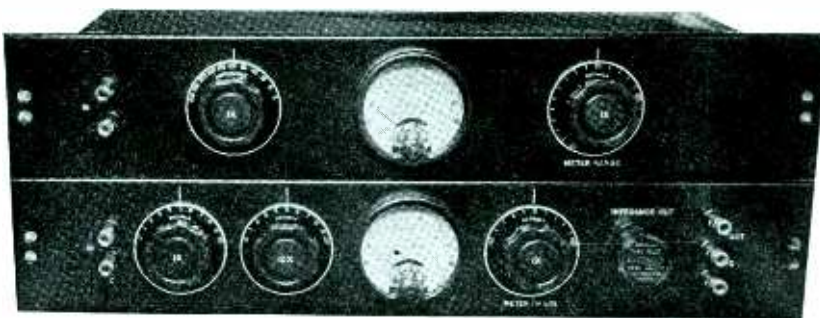

Illustrated above: Type 685—complete set—width 19", height 7" (overall)—for standard rack mounting. Also available in portable carrying case at slight additional cost.

Individual panels available. Type 688—Load Panel—top, above. Type 683—Transmitter Panel—bottom, above.

Type 685 assembly is a compact instrument for rapid, accurate measurement of audio amplifiers, transmission systems, and attenuation networks over the audio range.

All networks, meters, and associated apparatus thoroughly shielded, carefully balanced, matched for uniform accuracy over a wide frequency range.

- ATTENUATION RANGE +10 db to -120 db in steps of 1 db.
- POWER MEASURING RANGE -20 db to +36 db.
- LOAD IMPEDANCE Eleven values, ranging from 5 to 600 Ohms, are available.
- OUTPUT IMPEDANCES may be changed from Balanced to Unbalanced, and to any loss and impedance required by means of plug-in type matching networks.
- FREQUENCY RANGE 20 to 17,000 cycles.
- ACCURACY OF ATTENUATION CONTROLS  $\pm 1\%$ .

## THE DAVEN COMPANY

158-160 SUMMIT STREET

Phone MArket 2-2468

NEWARK, N. J.



## Frequency Measuring Service



Many stations find this exact measuring service of great value for routine observation of transmitter performance and for accurately calibrating their own monitors.

MEASUREMENTS WHEN YOU NEED THEM MOST  
at any hour every day in the year

R.C.A. COMMUNICATIONS, Inc.

Commercial Dept.

A RADIO CORPORATION OF AMERICA SERVICE

66 BROAD STREET

NEW YORK, N. Y.

## WAXES • COMPOUNDS • VARNISHES for ELECTRICAL INSULATION

Zophar offers prompt service on Insulating Compounds for a wide variety of electrical applications, including:

... insulation for CONDENSERS, TRANSFORMERS, COILS, power packs, pot heads, sockets, wiring devices, wet and dry batteries, etc. Also WAX SATURATORS for braided wire and tape. WAXES for radio parts.

Special compounds made to your order.

# ZOPHAR MILLS INC.

130-26th St.

Brooklyn, N. Y.

FOUNDED 1846

# REMLER ATTENUATORS



Standard impedances of 50, 200, 250 and 500 ohms. Special values to order.

## BALL BEARING ROTOR SHAFT • CLOCK SPRING PIGTAIL

### Praise!

One engineer writes: "... in almost daily service since 1933 ... to date we have never had a noisy or defective Remler Attenuator". Another letter states: "Compared to attenuators which require cleaning every month to six weeks, your attenuators have been outstanding. We know of no other attenuators that have even closely approached the service given by our Remlers."

Unequaled ease of operation and long life. Attenuation variable in 27 steps of 1 2/3 db. per step up to 45 db. fading in three additional increasing steps from 45 db. to infinity. A single sliding contact in the input circuit results in contact noise being attenuated within the unit in direct proportion to the loss introduced in the circuit, providing a constant signal-to-noise ratio. Impedance practically constant over the entire range of the pad. DLA type, silver contacts, \$12.80.

LA-5 Ladder Type—Net

**\$10.80**

**REMLER COMPANY, Ltd.**  
19th at Bryant San Francisco

# BLILEY



## CRYSTALS

The complete Bliley line includes ovens, holders and crystals for all frequencies from 20 kc. to 30 mc. Several new units have recently been developed for high frequency mobile work. Write today for Catalog G-10 for full description.

**BLILEY ELECTRIC COMPANY**  
UNION STATION BUILDING ERIE, PA.

## TWO GOOD REASONS



Your slippers, sir. Two good reasons why you'll enjoy our free radio catalog. It's more than a book of super-values. Here, a catalog that's such a blessed convenience, you won't want to be without a copy ever again! Saves running around, tiresome research and investigation. Best of all, it saves you important money on top-flight, nationally advertised merchandise.

**WHOLESALE RADIO SERVICE CO. INC.**  
100 SIXTH AVE., NEW YORK, N. Y.  
CHICAGO, ILL. • ATLANTA, GA. • BOSTON, MASS.  
BRONX, N. Y. • NEWARK, N. J. • JAMAICA, L. I.

1,710,073, 1,714,191, S. Ruben, Electrical condenser; 1,891,207, same, Electrolytic condenser, D. C., S. D. N. Y., Doc. E 79/143, *Ruben Condenser Co. et al. v. Cosmic Condenser Corp. et al.* Dismissed without prejudice (notice Jan. 4, 1938).

1,855,168, C. L. Farrand, Loudspeaker; 1,271,529, M. C. Hopkins, Acoustic device, D. C., E. D. Pa., Doc. 7881, *Lektophone Corp. v. Philadelphia Storage Battery Co., et al.* Dismissed Dec. 11, 1937.

1,901,331, E. S. Pridham, Electrodynamic loud speaker, D. C., N. D. Ill., E. Div., Doc. 15217, *The Magnavox Co. v. The Webster Co.* Dismissed without prejudice Sept. 20, 1937.

1,448,279, Pridham & Jensen, Electrodynamic receiver, D. C., N. D. Ill., E. Div., Doc. 15216, *The Magnavox Co. v. The Webster Co.* Dismissed without prejudice Sept. 20, 1937.

1,623,996, P. S. Carter, Radio transmission system; 1,909,610, same, Electric circuit; 1,974,387, same, Antenna; 1,884,006, 1,927,522, N. E. Lindenblad, same, appeal filed Feb. 14, 1938, C. C. A., 2d Cir., Doc—, *R. C. A. v. Mackay Radio & Telegraph Co., Inc.*

Re. 19,744, H. A. Wheeler, Volume control, filed Mar. 3, 1938, D. C., E. D. Mich. (Detroit), Doc. 8337, *Hazeltine Corp. v. Detrola Radio & Television Corp.*

1,707,545, E. C. Wentz, Acoustic device, D. C. Minn. (Minneapolis), Doc. E 2806, *Western Electric Co., Inc., et al. v. Cinema Supplies, Inc.* Decree for plaintiffs; injunction Feb. 10, 1938.

1,329,283, 1,398,665, H. D. Arnold; 1,349,252, same; 1,465,332, same; 1,403,475, same; 1,520,994, same; 1,448,550, same; 1,453,982, B. W. Kendall, Electrical receiving or repeating apparatus and method of operating same; 1,493,595, R. B. Benjamin, Electric-lamp socket; 1,544,921, R. C. Mathes, Amplifier circuit, D. C. Minn., 4th Div., Doc. E 2804, *Western Electric Co., Inc., et al. v. Cinema Supplies, Inc., et al.* Dismissed as to 1,349,252, 1,448,550, 1,493,595, and 1,544,921 Dec. 3, 1936. Decree for plaintiffs as to 1,329,283, 1,398,665, 1,403,475, and 1,520,994; injunction. Bill dismissed as to 1,453,982 and 1,465,332 Feb. 5, 1938.

1,507,016, L. de Forest, Radio signaling system; 1,507,017, same, Wireless telegraph and telephone system, filed Feb. 16, 1938, D. C., S. D. Calif., C. Div., Doc. E 1332-RJ, *Western Electric Co., Inc., et al. v. Bristow & Co., et al.*

Re. 19,744, H. A. Wheeler, Volume control, filed Feb. 15, 1938, D. C., E. D. Mich. (Detroit), Doc. 8322, *Hazeltine Corp. v. Sparks Withington Co.*

1,403,475, H. D. Arnold; 1,403,932, R. H. Wilson; 1,507,016, L. de Forest; 1,507,017, same; 1,618,017, F. Lowenstein; 1,936,162, R. A. Heising; Re. 18,579, Ballantine & Hull, filed Feb. 14, 1938, D. C., N. D. Ill., E. Div., Doc. 15,954, *R. C. A. et al. v. B. Friedman et al. (Lake Sales Co., Inc.)*.

1,573,374, P. A. Chamberlain, Radio condenser; 1,707,617, 1,795,214, E. W. Kellogg, Sound reproducing apparatus; 1,894,197, Rice & Kellogg, same; 2,052,-



Now—  
a high-powered—



**New**  
The Library now  
comprises a re-  
vised selection of  
books culled from  
latest McGraw-  
Hill publications  
in the radio field.

## RADIO ENGINEERING LIBRARY

— especially selected by radio specialists of McGraw-Hill publications

— to give most complete, dependable coverage of facts needed by all whose fields are grounded on radio fundamentals

— available at a special price and terms

These books cover circuit phenomena, tube theory, networks, measurements, and other subjects—give specialized treatment of all fields of practical design and application. They are books of recognized position in the literature—books you will refer to and be referred to often. If you are a researcher or experimenter—if your interest in radio is deep-set and based on a real desire to go further in this field—you want these books for the help they give in hundreds of problems throughout the whole field of radio engineering.

5 volumes 3064 pages, 2000 illustrations

1. GLASGOW'S PRINCIPLES OF RADIO ENGINEERING
2. Terman's MEASUREMENTS IN RADIO ENGINEERING
3. Chaffee's THEORY OF THERMIONIC VACUUM TUBES
4. Hund's PHENOMENA IN HIGH-FREQUENCY MEASUREMENTS
5. Henney's RADIO ENGINEERING HANDBOOK

Special Low Price and Easy Terms

Bought singly, the five volumes comprising this library would cost you \$26.00. Under this offer you save \$2.50 and, in addition, have the privilege of paying in easy installments beginning with \$2.50, 10 days after receipt of the books, and \$3.00 monthly thereafter. Already these books are recognized as standard works that you are bound to require sooner or later. Take advantage of these convenient terms to add them to your library now.

### SEND THIS ON-APPROVAL COUPON

McGraw-Hill Book Co., Inc.  
330 W. 42nd St., New York, N. Y.

Send me Radio Engineering Library 5 vols., for 10 days' examination on approval. In 10 days I will send \$2.50, plus few cents postage, and \$3.00 monthly till \$23.50 is paid, or return books postpaid. (We pay postage on orders accompanied by remittance of first installment.)

Name .....

Address .....

City and State .....

Position .....

Company ..... L-6-38

(Books sent on approval in U. S. and Canada only.)

316, R. E. Sagle, Variable condenser, filed Feb. 14, 1938, D. C., N. D. Ill., E. Div., Doc. 15955, R. C. A. et al v. B. Friedman et al. (Lake Sales Radio Co.).

1,403,475, H. D. Arnold; 1,403,932, R. H. Wilson; 1,507,016, L. De Forest; 1,507,017, same; 1,618,017, F. Lowenstein; 1,936,162, R. A. Heising; Re. 18,579, Ballantine & Hull, D. C., N. D. Ill., E. Div., Doc. 15954, R. C. A. et al v. B. Friedman et al. (Lake Sales Radio Co.). Consent decree finding patents valid and infringed, injunction Feb. 21, 1938.

## British Patents

Flaw detector. Liquid in a container is inspected for the detection of solid matter, etc., in the liquid by passing light through the liquid to a phototube, and so arranging the amplifying circuit that impulses are produced by abrupt change in the phototube current due to the presence of solid particles in the liquid. G. P. Stout. No. 469,949.

Reflectance measurement. Apparatus for comparing the color of light diffusely reflected from surfaces, comprising means for directing light or different colors normally on to the surface of a sample, phototube to be affected substantially only by light reflected diffusely from the surface, and a measuring device operatively associated with the phototube. General Electric Co. No. 469,999; also No. 470,454.

Photometer. In a photometer the phototube is smaller than the scale plate over which the pointer of the measuring instrument moves, and is disposed within the area of the plate. Weston. No. 470,134.

Counting system. Pulse counting, frequency dividing, or measuring apparatus comprising a condenser which on the operation of a switching device is

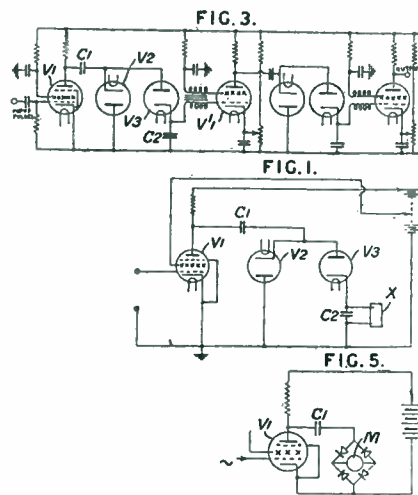

charged through one unidirectional conducting device and discharged through a similar one. E. L. C. White. No. 471,731.

Compressed Nitrogen Condenser TYPE 174

IMPROVED

Neoprene gaskets  
Corona shields  
Safety gap  
Increased breakdown voltage



RATINGS: (at 1 mc.)  
PEAK VOLTS 40,000  
R. M. S. AMPERES 80

HEINTZ AND KAUFMAN  
SOUTH CALIFORNIA  
SAN FRANCISCO U. S. A.



Self-Locking  
TILTING  
HEAD

★  
Cannot be  
Acoustically  
Overloaded

## NEW MULTI-UNIT Dual Diaphragm Crystal Microphone

An outstanding achievement in microphone construction for night club and public address installations. Maximum amplification without feedback. Cannot be acoustically overloaded. Made in two models. MU-2 constructed with two dual diaphragm crystal units using four diaphragms. MU-4 uses four dual diaphragm crystal units and eight diaphragms. Black and chrome. Complete with three-prong interchangeable locking connector and 25-ft. cable.

List Prices  
MU-2 \$29.50 : MU-4 \$39.50

ASTATIC

Astatic Microphone Laboratory, Inc.  
Dept. A-5 Youngstown, Ohio  
Licensed Under Brush Development Co. Patents



18 Styles  
2" to 7"



FAN TYPE

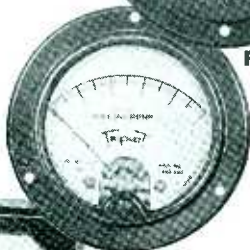

ROUND

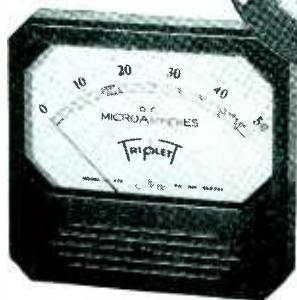

SQUARE

Most Models Available  
with  
FRONT OR REAR  
ILLUMINATION

FOR MORE INFORMATION  
WRITE—Section 239

Today's Most Modern Instruments . . . New methods and extremely accurate processes are embodied in Triplett instrument designs. The first considerations are for dependable accuracy, simplicity, and the best application of the fewest number of parts. An example is the long research in developing a super-magnet (the heart of the instrument) by means of which it has been possible to eliminate extra pole pieces. This achievement has brought from prominent laboratories, graphs that prove Triplett magnets give more uniform scale characteristics. Magnet air gaps are absolutely uniform because they are made without tolerance in size after the magnet is hardened by thoroughly proved exclusive Triplett processes. The same painstaking methods apply to aging of all materials after processing to relieve strains and assure proper adjustments; care in selecting pivots and jewels and applying them in exact alignment. Infinite care in every form is exercised throughout in Triplett's modern, fully air-conditioned plant under the supervision of engineers of long standing instrument building experience. This unique instrument setup is available to you as a most reliable complete organization where full confidence may be had in valuing such products to your needs.

TRIPLETT ELECTRICAL INSTRUMENT CO.  
Bluffton, Ohio

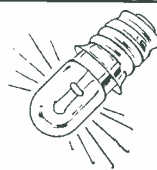

Pyrometer. In the measurement of high temperatures, the difference between the energy radiated by a highly heated body on two different wavelengths is utilized as a measure of the temperature. Also, a system for automatic temperature control. British Thomson-Houston Co. No. 472,146. See also No. 472,147 on a photoelectric photometer, Truecolour Film, Ltd.

Fuse control. A projectile is provided with a source of light adapted to throw out a beam of light on a target. For example, an aircraft and a light-sensitive cell adapted to receive the light reflected by the target and to cause thereby the ignition of a primer to explode the projectile. L. M. Ericsson. No. 472,322.

Direction finding. Two patents to F. Johnske. No. 472,419 and 472,420, on direction-finding systems.

Exposure meter. For limiting the light falling on the cell of a photoelectric exposure meter to rays having an angle of incidence not exceeding a predetermined limit, at least two trans-

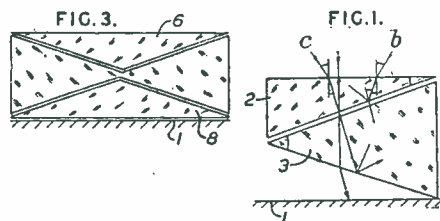

parent bodies having a definite refractive index are arranged in the light path, and are separated by a medium of lower refractive index. No. 472,448. Zeiss Ikon.

Engraving. A method of producing plates of the kind in which the printing surfaces are reticulated; the design to be copied is arranged upon a surface which is explored by one or more phototubes, the currents so generated being applied to one or more electromagnetically operated graters caused to explore a second surface, moved at a speed bearing a suitable relationship to the speed of the first surface, and to remove appropriate parts of a protective coating upon a printing plate arranged upon the second surface. F. Alice. No. 470,435.

Escalator control. Automatic control of moving stairways by photoelectric means. No. 472,963.

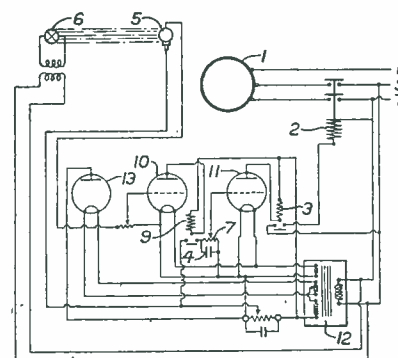

Here's How To Lick Your  
Relay Problems

Model 150  
Relay

When ordering specify current, voltage or resistance of coil, contact combination and load through contacts . . .

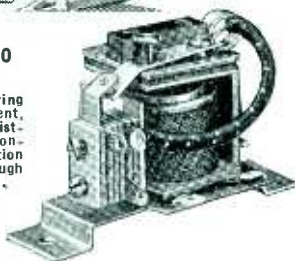

Save SPACE—Save MONEY

Relays by Guardian can supply the answer to your relay problem . . . no matter how simple or how exacting your requirements may be. Relays by Guardian are small in size, compact in design, positive in operation, efficient and dependable. They'll fit readily into any production routine or assembly line. Our catalog shows many types and models capable of unlimited variations to conform with your specifications. And . . . we can make almost INSTANT delivery!

Write today for catalog E.

**GUARDIAN G ELECTRIC**  
1625 W. WALNUT STREET CHICAGO, ILLINOIS

STUDIO QUALITY IN A  
PORTABLE RECORDER



Recording technicians are amazed at the perfect studio quality of work produced on the RADIOTONE PR-16 Portable Recorder. This 16-inch, dual-speed Recorder has numerous features that make it most flexible as well as giving it most faithful reproduction.

During the past two months many Radio Stations have purchased the RADIOTONE PR-16. For details and names of users, write today to

**Radiotone Inc.**

620 N. Michigan Blvd. Chicago  
7356 Melrose Avenue Hollywood



**Metal-working apparatus.** In a heat-treating process and apparatus for cutting, welding, or surface treating metals a portion of the work is heated to the required temperature and the work and source of heat moved relatively to present successive portions for heating, the movement being controlled by radiation from the heated surface by electronic means. Linde Air Products Co. No. 470,546.

**Conveyor system.** A switching device for guiding a carrier in a pneumatic conveyor system is operated by changes in plate current of a grid-controlled tube, the grid biasing potential of which is controlled by the moving carrier. Lamson Pneumatic Tube Co., Ltd. No. 470,560.

**Sorting system.** Method for examining and sorting documents, such as ballot papers or competition coupons, according to the arrangement of symbols such as numerals or letters in selected positions in columns on the document or a page or sheet thereof. Each sheet is examined by comparing it with a standard sheet, on which the markings have been made in predetermined arrangement, and the comparison is effected by simultaneously scanning the sheet under examination and the standard sheet. L. J. Blumenthal. No. 470,638.

**Infra-red ray detectors.** A pair of thermo-electric current generators of minute mass, onto one of which rays from a distant radiator are focused by means of a parabolic mirror while the other is completely shielded from such rays. R. Wood, L. Mosley, and H. Dunkley. No. 470,846.

**Exposure meter.** A polarizing filter of the kind which may be angularly adjusted to remove disturbing reflections from the field of view is mounted in or in front of the view opening of a photoelectric exposure meter. Zeiss Ikon. No. 471,016.

**Ignition system.** A tripping voltage applied to the grid of a tube causes the discharge of a condenser through the primary of a transformer, the condenser being arranged across a supply of unidirectional current, and the secondary winding connected to a distributor feeding the engine spark plugs. For applying the tripping voltage, an engine-driven perforated disc may control a photoelectric tube in circuit with the grid of the tube. British Thomson-Houston Co. No. 472,688.

**Copying.** In a system for producing monochromatic pictures corresponding to the colors of a polychromatic picture, color separated pictures or corresponding negatives are scanned by photoelectric means. No. 472,870. B. Bubnoff.

**Vehicle control.** Infra-red rays transmitted by a vehicle control signal at a crossroad. No. 473,044.

# CLARE RELAYS

ELECTRONIC INDUSTRIAL

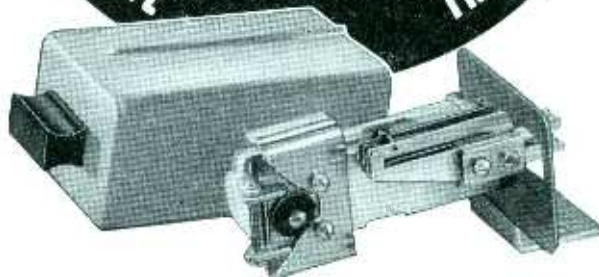

All CLARE relays are built to adhere minutely to exacting individual specifications. CLARE engineers are schooled and thoroughly appreciate that the efficiency of your production depends largely upon the accuracy of construction and careful choice of material used in the relays you install — therefore, nothing short of perfection counts. CLARE relays are not merely manufactured, they are the result of scientific designing, permitting micromatic fulfillment of every specification detail. You are invited to consult the CLARE engineers on your problems without obligation.

Write for  
Descriptive  
Catalog  
CC1



**C. P. CLARE & CO.**  
LAWRENCE & LAMON AVES. - CHICAGO  
15 EAST 26TH STREET, NEW YORK CITY

## You get SOFT IRON POLE PIECES AND FULL BRIDGE CONSTRUCTION in Simpson panel instruments at the price of ordinary construction

**B**EFORE you place your next order for panel instruments why not check up on the Simpson line. These new panel instruments have already established a remarkable record for their continuous accuracy under difficult service conditions. They are the first and only soft iron

pole piece bridge-type instruments without the price premium of this finer type construction. Manufacturers, laboratory technicians, radio amateurs and radio service men everywhere are selecting Simpson's "more for the money" panel and portable instruments.

SIMPSON ELECTRIC CO., 5212 Kinzie St., Chicago



Popular 3" panel Model 25-S Milliammeter with Bakelite case.



Rectangular type Model 29-S Voltmeter in 4 1/2" Bakelite case.



Fan shaped Model 22-S Microammeter in 4 1/2" Bakelite case.



The Model 27-S Milliammeter in 3" rectangular Bakelite case.



## SIMPSON Instruments that STAY accurate

You will want this new catalog — Just mail the coupon for your copy.

SIMPSON ELECTRIC CO.  
5212 Kinzie St., Chicago, Ill.  
Send your new catalog No. 10 on your line of panel and portable instruments.  
Name \_\_\_\_\_  
Company \_\_\_\_\_  
Street \_\_\_\_\_ City \_\_\_\_\_ State \_\_\_\_\_

**SENSITIVE ELECTRONIC  
AC VOLTMETER  
MODEL 300**



- New principle
- 10—100,000 cycles
- 1 millivolt to 100 volts in five ranges.
- Logarithmic voltage scale and uniform decibel scale.
- A-C operation, 115 volts 60 cycles.
- Stable calibration unaffected by changes in line voltage, tubes, etc. Accuracy 2%.
- Can also be used as an amplifier (70 DB gain) flat to 100,000 cycles.

**MODEL 400  
SOUND METER  
ATTACHMENT**

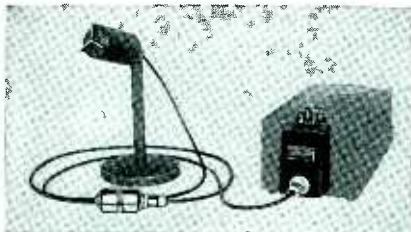

Converts Model 300 Voltmeter into direct-reading sound-pressure meter for sound and noise measurements, loudspeaker tests, etc. Comprises high-grade dynamic microphone accurately calibrated against Rayleigh disk, input transformer, attenuator and equalizer for compensating frequency curve of microphone. Range 30-10,000 cycles, reading down to 1 bar rms. Can be used with any Model 300 Voltmeter.

Write for Bulletin 2B.

**Ballantine Laboratories, Inc.**  
BOONTON NEW JERSEY

# NEW BOOKS

## Radio-Frequency Electrical Measurements

By HUGH A. BROWN. *Second edition.*  
McGraw-Hill Book Co., New York.  
Price, \$4.00. 384 pages.

AS A GUIDE for radio engineering laboratory instruction, Prof. Brown's book is intended to be useful to the practicing engineer, the student of communications, and the radio amateur. Individual chapters deal with measurements of circuit constants; measurement of frequency; antenna measurements; electro-magnetic-wave measurements; measurement of electron tube coefficients and amplifier performance; electromotive force, current, and power; measurement of wave form; and modulation, receiver, and piezo-electric crystal measurements. There are frequent references to the technical literature, and the material chosen for treatment is well selected.

The manner in which the subject matter is treated is, however, another story. Prof. Brown never regains the clear, lucid style of the first eight pages, and frequently leaves the reader with the impression that, for a second edition, the volume is pretty heavy with technical ambiguities and loose statements. A first class job of technical editing would have improved the second edition considerably.—B.D.

## Motion Picture Sound Engineering

Research Council of the Academy of Motion Picture Arts and Sciences. *D.*  
Van Nostrand Co., New York, 1938.  
(550 pages, 380 illus. Price \$6.00).

A SERIES of lectures given to classes enrolled in sound engineering courses offered by the Research Council of the Academy of Motion Picture Arts and Sciences has provided the basic material from which the chapters of this book were prepared. The first of two parts into which the book is divided deals with equipment and the applications of electrical and acoustic principles to motion picture engineering. In the second part, the foundation is laid for an understanding of the physical principles applied. Thirty-nine chapters deal with the wide range of subjects likely to confront the technician engaged in motion picture recording, processing, or projection. Five chapters deal specifically with electron tubes and their circuits, and many more are of direct interest to the communication engineer.

Some question might be raised as to

the meaning of gamma of a light valve, printing machine, or photoelectric cell, used without explanation in the section on film processing, especially since the term, as used, is not commonly employed in photographic or electrical work. Equations for decibels are converted from a power basis to one of current and voltage without stating the requirements of constancy of terminating impedances; indiscriminate use is made of  $s_m$  and  $G_m$  for transconductance, and the statement on page 347 that "the mutual conductance value is about the same for all tubes of the same size, so that tubes of high  $\mu$  also have high plate impedance" might well be questioned. Such ambiguities and inconsistencies as have come to the reviewer's attention are not regarded as being serious for the purpose for which the book is intended, and are exceedingly difficult to avoid where manuscripts are prepared by several authors. Indeed, with many persons co-operating in the preparation of this book, it is no minor accomplishment to get all the manuscripts to the printer!

Material is taken, when necessary, from various acknowledged sources. Aside from the credit lines, no bibliographical references are given which might lead the reader to more detailed treatments of the various subjects.

No single book could possibly treat exhaustively those branches of physics and engineering with which sound motion picture technicians may be expected to be familiar. But "Motion Picture Sound Engineering" does a remarkably good job of treating (in less than 600 pages) the essentials of sound recording and reproducing, film processing, transmission circuits, electron tubes and their circuits, and the fundamentals of electric circuit theory. To the technician it should quickly become an important reference work on sound motion picture.—B. D.

## Photoelectric Cell Applications

By R. C. WALKER and T. M. C. LANCE.  
*Third edition.* Pitman Publishing  
Co., New York. 1938. Price \$6.00.  
336 pages. 200 illustrations.

THE TITLE GIVES a good description of the contents of the book although such devices as iconoscopes and electron multipliers which are rather advanced elaborations of the photoelectric cell are also treated. The first chapter discusses the characteristics of alkali metal phototubes, and this is followed by a chapter on the fundamentals of applying photoelectric devices. The remaining chap-



ters are devoted to applying photoelectric units to counting, timing, and mechanical handling of goods; alarms, indicators, and safety devices; advertising; sound reproduction; telephotography; television; scientific instruments; and miscellaneous applications.

The text is descriptive in character, and only a few equations of the simplest algebraic variety are used. No attempt is made to treat the more involved aspects of the photoelectric effect or to go into circuit analysis. For those who desire this type of information, the authors have provided a bibliography at the end of each chapter. But for those who desire an introduction to the use and application of photoelectric devices, this volume should fill a persistent demand. The text does very well in fulfilling the authors' intention of "simplicity of treatment, with the hope that our descriptions may prove helpful to the practical man and suggest to him means of attacking some of his problems with a new weapon".—B.D.

### Introduction to Radio Engineering

(Einführung in die Funktechnik.  
Verstärkung, Empfang, Sendung)

BY FRIEDRICH BENZ. *Julius Springer, Vienna. 1937. 411 pages, 443 figures. Price 15 R.M., Bound 16.80 R.M.*

THIS BOOK covers a very wide range of well-chosen material of fundamental importance in radio engineering. The material is modern and is concisely treated without undue elaboration of any particular subject. Enough mathematics, including some use of differential equations and series expansions, is used to cover the theoretical developments satisfactorily. Complex numbers are explained and used in the calculation of a-c problems. Numerical problems and their solutions are given at numerous places in the text. It is not possible to give in any detail the subject matter which is covered other than to state broadly that the book gives the fundamentals of almost all subjects of interest to the radio engineer. The references are almost entirely to German articles; likewise, the specific descriptions of apparatus such as receivers are of German devices.

The book suffers by reason of the inclusion of a number of fairly serious errors, some accidental and some of fact. In the explanation of the internal plate resistance of a vacuum tube (page 108), reference is made to a figure (Fig. 107) in which the abscissas are grid voltage where they should be plate voltage. In another place (bottom page 112), the statement is made that the alternating voltage on the plate of a triode is in phase opposition to the grid voltage regardless of the character of the plate load impedance which would only be true in case the internal plate resistance of the tube is negligible. In Fig. 12, page 113, in the expression for the

voltage between the grid and plate, the component  $U_{gw}$  should have a minus sign and also in Fig. 113, page 115, the various voltages given for  $U_g$  should be minus. On page 124 the misleading statement is made with respect to shot-effect that "The frequencies of these alternating currents lie in the audible region." On page 237 with respect to screen-grid tubes "with careful shielding", the effective grid-anode capacity is given as a few tenths of a centimeter whereas it should read hundredths or thousandths. On page 237, the nomenclature with respect to

### PUBLIC LOUDSPEAKERS



In Germany, thousands of loudspeakers are being installed permanently in the public square of every town and large village, so the populace can hear political speeches and news of world events from headquarters at Berlin and Munich. Above is a loudspeaker installation "camouflaged" as a clock tower

plate and grid neutralization is reversed, at least from American practice. On page 323, just above equation (8), the equation  $R_w = 2R_a$  should read  $R_w = 4R_a$ . By reason of this error, equation (8) should have the numerator "4" instead of "2", and also equation (10), page 327, should have "2" for a numerator. This error occurs also in the text at the bottom of page 326. In Fig. 363, page 329, representing the circuit diagram of the grid-dynatron, the grid and plate voltages should be interchanged.

The average radio engineer, however, will find much of value both for reading and reference. This book should be valuable to one desiring to combine improvement of his technical German vocabulary with worthwhile reading.—J.M.M.

## RADIO NOISE and FIELD STRENGTH Meter

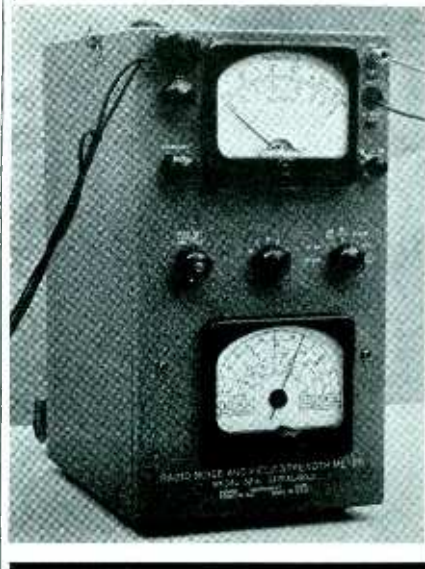

### FERRIS MODEL 32

A universal microvoltmeter for measuring all types of radio noise or radio carrier fields. Compact, portable, accurate, and useful in both field and laboratory measurements.

- For noise surveys, field intensity surveys, measurements of noise voltages on conductors.
- For acceptance tests of electrical equipment, design of noise reduction equipment, and tests on filters.
- Frequency coverage, 150 to 350 and 550 to 20,000 kilocycles.
- Input voltage range 1 to 100,000 microvolts. Field intensity range 2 to 200,000 microvolts per meter with half-meter antenna supplied.
- Self-calibrated with built-in calibrating generator, to make real measurements instead of mere comparisons.
- Output meter has three-decade logarithmic scale. Tests show this to be the only type of meter satisfactory for practical use.
- Standard power supply, dry batteries. Interchangeable packs for storage battery or 115 volt line operation.

### Write for DATA . . .

- Descriptive bulletin E-32 will be sent on request. Bulletins on Ferris signal generators and other measuring equipment also available.

## FERRIS INSTRUMENT CORPORATION

BOONTON • NEW JERSEY



# FERROCART

**Cores for permeability tuned push-button systems**

1. Low frequency drift
2. Easy adjustment
3. Compact
4. Economical

May be supplied in various permeabilities for antenna, R.F. and oscillator coil tuning. Systems using our standard grade AA in antenna coils may be tracked for 455 KC using our color-coded low  $\mu$  oscillator cores with closely held tolerances of all permeability values.

Entirely dependable close electrical and physical tolerances and uniformity. Prompt deliveries of any large quantity of the above as well as of high "Q" or high permeability cores for antenna, R.F. and I.F. coils.

Many standard designs of screw cores, pot cores, etc.

*Inquiries invited.*

**FERROCART**  
CORPORATION OF AMERICA  
HASTINGS-ON-HUDSON, N. Y., U.S.A.

## For FLASHING of LIGHTS on a Continuous Cycle

This Dunco type TD-247 Electronic Time Delay is of the repeating type designed to flash lights at the rate of 40 flashes per minute. Dunco Timers are available for any timing combination.



Let us know your requirements.

**Struthers  
Dunn, Inc.**  
131 N.  
Juniper  
St.  
Philadelphia,  
Pa.

**DUNCO**  
Electronic Type  
**TIMERS**



## Electron Art

(Continued from page 59)

### A Simple D-C Amplifier

FOR MANY YEARS the problem of stable amplification at zero frequency and preferably with readily available equipment has engaged the attention of electronic technicians. The d-c amplifier using a standard tube is described by

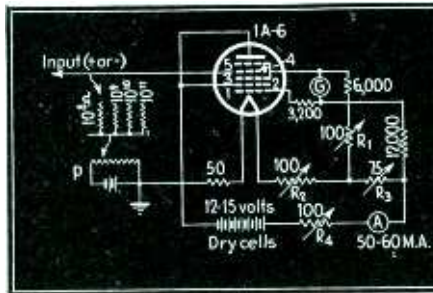

Tatel, Moncton and Luhr, in the July issue of the *Review of Scientific Instruments*.

The authors point out that most standard radio tubes are not suitable for measurements of very low currents because the cathode is oxide coated and therefore the emission is unstable, or because the grids are improperly arranged. For good insulation, the lead from the control grid should emerge separately from the top of the glass tube and this requirement automatically restricts the choice to such tubes as the 1A6, or the 1C6. The 1A6 tube was chosen because it operates with a filament current of only 50 to 60 milliamperes.

Fig. 1 shows the diagram of the complete single tube amplifier. With the exception of the high resistance grid leaks and the galvanometer, all of the parts may be purchased at any radio supply house for a modest sum. The diagram is essentially that described by DuBridge and Brown in the *Review of Scientific Instruments* for April 1933. The variable resistors,  $R_1$ ,  $R_2$ ,  $R_3$  and  $R_4$  are for the purpose of balancing and adjusting the filament current, whereas the circuit itself is balanced by changing  $R_2$  and  $R_3$  until a condition is found for which a small change of  $R_4$  causes the galvanometer to reverse its deflection. The resistor  $R_1$  is used as a fine adjustment of this balance.

With a Leeds & Northrup galvanometer having a sensitivity of  $2.2 \times 10^7$  mm per volt, and an internal resistance of 470 ohms, a scale deflection of 10,000 mm per volt applied to the input grid has been obtained. With a grid leak of  $10^{11}$  ohms, this represents a current sensitivity of  $10^{-15}$  ampere per mm of deflection of the galvanometer. The authors do not mention that they found it necessary to treat the tube or the high resistances in any other than the usual procedure.

### Influence of Magnetic Field on Plate Resistance

ONE OF THE research items in the August issue of the *Electro-Technical Journal*, monthly publication of the Institute of Electrical Engineers of Japan, deals with the effect of magnetic field on the i. r. of a thermionic tube.

By measuring the static plate characteristics of the tube with and without a magnetic field applied, it is shown, as might be expected, that the magnetic field produces considerable effect on the internal resistance. The measured characteristics are shown in Fig. 1. Curve A shows the characteristics when the magnetic field is not applied. B shows the application of the magnetic field perpendicular to the surface of the plate of the vacuum tube, and C shows the condition in which the magnetic field is applied parallel to the plane of the

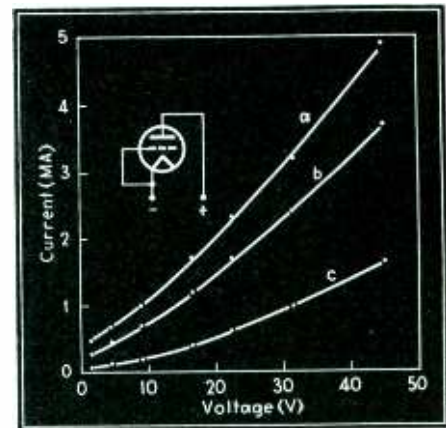
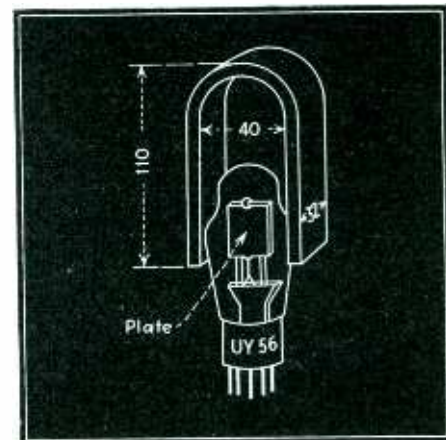

plate as shown in Fig. 2. It is found that the internal resistance varies from 10,000 to 25,000 ohms due entirely to the influence of this magnetic field.



Presumably the magnitude of the effect will depend upon the structure of the electrodes. Qualitatively, however, the effect has been observed in two different types of tubes, and there is no reason to suppose that other types would not also show the same effect.



# SEARCHLIGHT SECTION

EMPLOYMENT : BUSINESS : OPPORTUNITIES : EQUIPMENT—USED or RESALE

UNDISPLAYED RATE:  
10 cents a word, minimum charge \$2.00.

Position Wanted, (full or part-time salaried employment only), 1/2 the above rates, payable in advance.

Proposals, 40 cents a line an insertion.

INFORMATION:

Box Numbers in care of our New York, Chicago, or San Francisco offices count 10 words additional in undisplayed ads. Replies forwarded without extra charge.

Discount of 10% if full payment is made in advance for four consecutive insertions of undisplayed ads (not including proposals).

DISPLAYED—RATE PER INCH:

1 inch .....\$6.00  
2 to 3 inches..... 5.75 an inch  
4 to 7 inches..... 5.50 an inch

An advertising inch is measured vertically on one column, 3 columns—30 inches—to a page. Contract rates on request.

(New advertisements must be received by September 30 for the October issue) Elect.

## POSITIONS WANTED

**CATHODE RAY TUBE ENGINEER:** Three years design, development and production cathode ray and associated tubes. Background, ten years radio tube, photocell and rectifier production and development. Associate IRE, 35, married. Past patent disclosures, important patent application pending. Competent take charge television tube program for some concern entering this field. PW-157, Electronics, 330 West 42nd St., New York City.

**YOUNG MAN,** now employed, desires permanent connection anywhere. Best of references. Experience, four years broadcast engineer and three years development and manufacture inter-communication equipment. PW-158, Electronics, 520 North Michigan Ave., Chicago, Illinois.

## POSITIONS WANTED

**RADIO ENGINEER** 35, 13 years experience, superheterodyne development, research, marine receiver, and test equipment radiotelegraphers license. PW-160, Electronics, 330 West 42nd Street, New York City.

**BROADCAST ENGINEER,** first class radio-telephone license, familiar with broadcast procedure and equipment. Ambitious; desirous of furthering experience. Age 20, single, available immediately any location. PW-161, Electronics, 330 West 42nd Street, New York City.

## REPRESENTATIVE WANTED

WANTED district Representative by old, established manufacturer of electronic equipment selling direct to industrial accounts. RW-159, Electronics, 330 West 42nd Street, New York City.

**Who**  
—beside yourself—  
**Reads** ?  
this paper

### Radio Sets, Tubes, Parts

Engineers, executives and other personnel engaged in the design, manufacture, sales or maintenance and service of home radio receivers, home facsimile or television equipment, radio-phonograph combinations or home phonographs; and components entering these or other home entertainment devices.

### Communications

Management, engineering, operation and other personnel of broadcast, police, aircraft, ship, amateur, government, state, municipal, point-to-point, ship-to-shore radio stations or systems; telephones and telegraph systems, wire, radio, carrier or space communications; and manufacturers of equipment and components entering into such wire and radio station equipment.

### Sound Pictures and Public Address

Personnel in sound pictures and electrical transcription recording studios; in studios recording sound for home, public address or theatre entertainment; manufacturers and users of public address equipment; and manufacturers of components entering into this type of equipment.

### Industrial Electron-Tube Equipment

Personnel in the plants of manufacturers and users of electron tubes and associated apparatus for industrial purposes such as control, power conversion and transmission, packaging, sorting, counting, traffic control, etc., medical equipment and components entering into such equipment.

### Miscellaneous

Patent Attorneys, Consulting Engineers, Government, Public Libraries, Universities, Teachers and Students, etc., etc., etc.

Have you a business message for any of these men? Employment Equipment or Business needs or "opportunities" to bring to their attention? You can do so quickly, effectively and at small cost through advertising right here—in

The SEARCHLIGHT SECTION  
of ELECTRONICS

## CHAS. EISLER'S

Equipment

Has Produced

**MILLIONS**

750 S. 13th St. (Near Avon Ave.)

## FOREMOST IN THE ELECTRONICS FIELD FOR OVER 20 YEARS!

Charles Eisler's equipment for the production of radio and electronic tubes, incandescent lamps, X-ray and cathode ray tubes, photo-electric cells, mercury switches, and neon signs has met the severest demands of industry in operating at the lowest cost and highest efficiency. If you are in the market for any of this or allied equipment including electric spot welders up to 250 KVA, butt, and arc welders, get in touch with us. Write for our "colleges and glass working laboratory units" catalog if interested in equipment for instruction purposes.

EISLER ENGINEERING CO. Newark, N. J.

**COMMUNICATIONS  
RECEIVERS**  
▼ RME ▼  
**NATIONAL  
HAMMARLUND  
HALLICRAFTERS**  
IN STOCK AT ALL TIMES  
**CAMERADIO**

963 LIBERTY AVE. • 30 TWELFTH ST.  
PITTSBURGH PA. WHEELING, W. VA.  
Established 1919

## HIGH GRADE NEW AND USED ELECTRON TUBE EQUIPMENT

Huge Stock of Equipment of  
Every Type and Variety

**KAHLE ENGINEERING CORPORATION**  
Specialists in Equipment and Methods for the  
Manufacture of Neon Tubes, Radio Tubes, Incan-  
descent Lamps, Photo Cells, X-ray Tubes, etc.  
941 DeMott St., North Bergen, N. J.

## VACUUM THERMOCOUPLES

Separate Heater and Contact Types,  
Mounted and Unmounted

Ranges from 1 Millamp and up  
Write for Bulletin "A"

**American Electrical Sales Co., Inc.**

65-67 E. 8th St., New York, N. Y.

## INSULATION TESTING EQUIPMENT

AC and DC

Photo Electric Cell Control Devices

Designed and Built to Meet Your

Requirements

Send Us Your Problems

**Associated Research, Inc.**

16 N. May Street CHICAGO, ILL.

## SOLENOID COUNTERS



New four-wheel counters—1300 ohm 24-48 v. d.c.

These counters have many applications in photo-electric cell work, broadcasting stations, and industrial uses. Original cost \$6.50; while limited stock lasts, \$2.00 each; 3 for \$5.00. C.O.D. only. Perfect cond. guaranteed or money refunded.

### FEDERAL SALES COMPANY

26 S. Jefferson St. CHICAGO, ILL.

radio equipment . . .  
for Broadcasting Stations  
Engineers • Laboratories  
We carry at all times a most  
complete line of  
Public Address Equipment

Call or Write

**TERMINAL**  
Radio Corporation

80 Cortlandt Street, New York, N. Y.  
BArcley 7-0622 Cable address: TERMRADIO

## DEPENDABLE

New and Used

### ELECTRONIC TUBE EQUIPMENT

A complete line of equipment for the manufacture  
of Radio Tubes, Neon Tubes, Incandescent Lamps,  
etc.

Write for Bulletin showing savings from 25 to 75%  
**EISLER ELECTRIC CORP.**  
534 39th Street, Union City, N. J.

Meters repaired, made more serviceable.  
Conversion to higher sensitivity as high  
as 10 microamperes for Weston type I  
or 24-57.

Sensitive vacuum thermo-couples  
For Sale used Weston panel meters.  
Rawson microammeters, Brown pyrom-  
eters.

Reasonable Prices  
**Precision Electrical Instrument Co.**

561 Broadway, N. Y. C.

WE'LL  
MAKE  
AS FEW  
AS  
50!

**SMALL QUANTITIES**  
are our specialty—send us your  
order for prompt service.  
R. F. Cells (Duo-Lateral and  
Solenoid)  
Amplifiers (Audio & Radio Fre-  
quency)  
Mechanical Design, Assembly and  
Electrical Development  
Ask us first—let us cooperate  
**ALES & FENER**  
132 Nassau St., N. Y. BE 3-2062

**MICROMETER** for  
**FREQUENCY** checking  
**METER** transmitters,  
up to 56 megacycles  
**LAMPKIN LABORATORIES**  
BRADENTON, FLORIDA



**MIDGET "MEGGER" CIRCUIT  
TESTING OHMMETER**



**Independent of Battery Voltage**  
Ranges—from .1 ohm up to 200,000 ohms

Quite different from a voltmeter calibrated in ohms, this direct-indicating "Megger" Ohmmeter requires no adjustment for the voltage of the battery that supplies current for the test. The instrument is a true ohmmeter of the "Megger" cross-coil type. For laboratory, shop and portable use for checking coils, resistors, contacts, windings, circuits, relays, etc., and even insulation resistance up to 200,000 ohms. Molded case, mottled green in color. Write for descriptive Bulletin 1495-E.

**JAMES G. BIDDLE CO.**

**ELECTRICAL INSTRUMENTS**  
1211-13 ARCH STREET PHILADELPHIA, PA.

**The heart of the 280 tube**

**WILBUR B. DRIVER CO.**  
NEWARK, NEW JERSEY

**INDEX TO ADVERTISERS**

Acheson Colloids Corp.....	67
Alliance Mfg. Co.....	72
Allied Control, Inc.....	70
American Automatic Electric Co.....	62
American Screw Co.....	42, 43
American Transformer Co.....	58
Astatic Microphone Laboratory, Inc.....	77
Audak Co.....	57
Bakelite Co.....	41
Ballentine Labs., Inc.....	80
Biddle Co., James G.....	84
Bliley Electric Corp.....	76
Brush Development Co.....	65
Callite Products Division.....	62
Cannon Elec. Development Co.....	69
Carborundum Co., Globar Div.....	56
Centralab Div., Globe-Union Co.....	7
Cinaudagraph Corp.....	64
Cinch Manufacturing Co.....	3
Clare & Co., C. P.....	79
Continental Carbon Co.....	66
Continental-Diamond Fibre Co.....	
Inside Back Cover	
Continental Screw Co.....	42, 43
Corbin Screw Co.....	42, 43
Cornell-Dubilier Elec. Corp.....	51
Daven Co.....	75
Driver Co., Wilbur B.....	84
Du Mont Laboratories, Inc., Allen B.....	66
Dumont Electric Co.....	72
Dunn, Inc., Struthers.....	82
Erie Resistor Corporation.....	46
Ferranti Electric, Inc.....	63
Ferris Instrument Co.....	81
Ferrocarril Corp. of America.....	82
General Electric Co., Textolite Div.....	50
Goat Radio Tube Parts, Inc.....	40
Guardian Elec. Corp.....	78
Heintz & Kaufman, Ltd.....	77
International Nickel Co., Inc.....	6
International Resistance Co.....	37
Jones, Howard B.....	74
King Laboratories, Inc.....	69
Lapp Insulator Co.....	45
Leach Relay Co.....	84
Lenz Electric Co.....	47
Lingo & Son, Inc., John E.....	68
Littelfuse Laboratories.....	84
Mallory & Sons, P. R.....	8
McGraw-Hill Book Co.....	77
National Screw.....	42, 43
Ohmite Manufacturing Co.....	64
Parker-Katon Corp.....	42, 43
Phillips Screws.....	42, 43
Pioneer Gen-E-Motor Corp.....	73
Post Co., Frederick.....	59
Precision Resistor Co.....	72
Presto Recording Corp.....	53
Radio Corporation of America.....	55
Radiotone, Inc.....	78
Raytheon Mfg. Co.....	74
RCA Communications, Inc.....	75
RCA Manufacturing Co.....	70
Remler Co., Ltd.....	76
Richardson Co.....	71
Russell, Burdell & Ward Bolt & Nut Co.....	42, 43
Shakeproof Lock Washer Co.....	4, 5
Shure Brothers.....	61
Simpson Electric Co.....	79
Sigma Instruments, Inc.....	74
Solar Manufacturing Co.....	Inside Front Cover
Speer Carbon Co.....	48
Superior Tube Co.....	39
Triplet Electrical Instrument Co.....	78
United Electronics Co.....	44
Universal Microphone Co.....	70
Ward Leonard Electric Co.....	38
Western Electric Company.....	49
White Dental Mfg. Co., S. S.....	2
Wholesale Radio Service.....	76
Zophar Mills.....	75

Professional Services..... 71

**SEARCHLIGHT SECTION**  
*Classified Advertising*

EMPLOYMENT.....	83
EQUIPMENT FOR SALE	
Alesi & Fener.....	83
American Electrical Sales Co., Inc.....	83
Associated Research, Inc.....	83
CameRadio Co.....	83
Eisler Electric Corp.....	83
Eisler Engineering Co.....	83
Federal Sales Co.....	83
Kahle Engineering Corp.....	83
Lampkin Laboratories.....	83
Precision Electrical Instrument Co.....	83
Terminal Radio Corp.....	83

**SEE!**  
ALL EYES ON LITTELFUSE



Send  
FOR  
CATALOG

**LITTELFUSE INCORPORATED**  
4248 LINCOLN AVE. CHICAGO, ILL.

**LEACH LR RELAYS**

**POSITIVE  
PROTECTION**

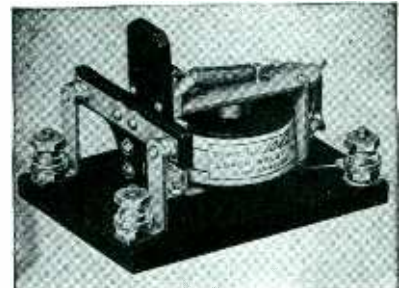

For Your Power Tubes. These light duty overload trip relays have a wide field of use as safety devices on electronic apparatus. Operation is unusually dependable. Scores of nationally known concerns rely on Leach Relays for protection.

**Leach Relay Company**  
5915 Avalon Boulevard,  
Los Angeles, Calif.

**SEND  
COUPON**

Leach Relay Co., 5915 Avalon Boulevard, Los Angeles, Calif.  
Please send me your catalog.

Name..... Company..... Address..... City.....



# NEW

## Handbook and Catalogue for Designers

**CONTAINING REVISED  
NEMA STANDARDS**

Many improvements have been made in the last year in laminated phenolic plastic products in which field DILECTO is a leader. Special grades have been perfected which offer much higher electrical and mechanical properties than were thought possible a few years ago. This new DILECTO catalog gives specific technical data on these new grades. It also gives the new NEMA standards on laminated plastics. You can bring all your data up to date by getting a copy of this new DILECTO catalog.

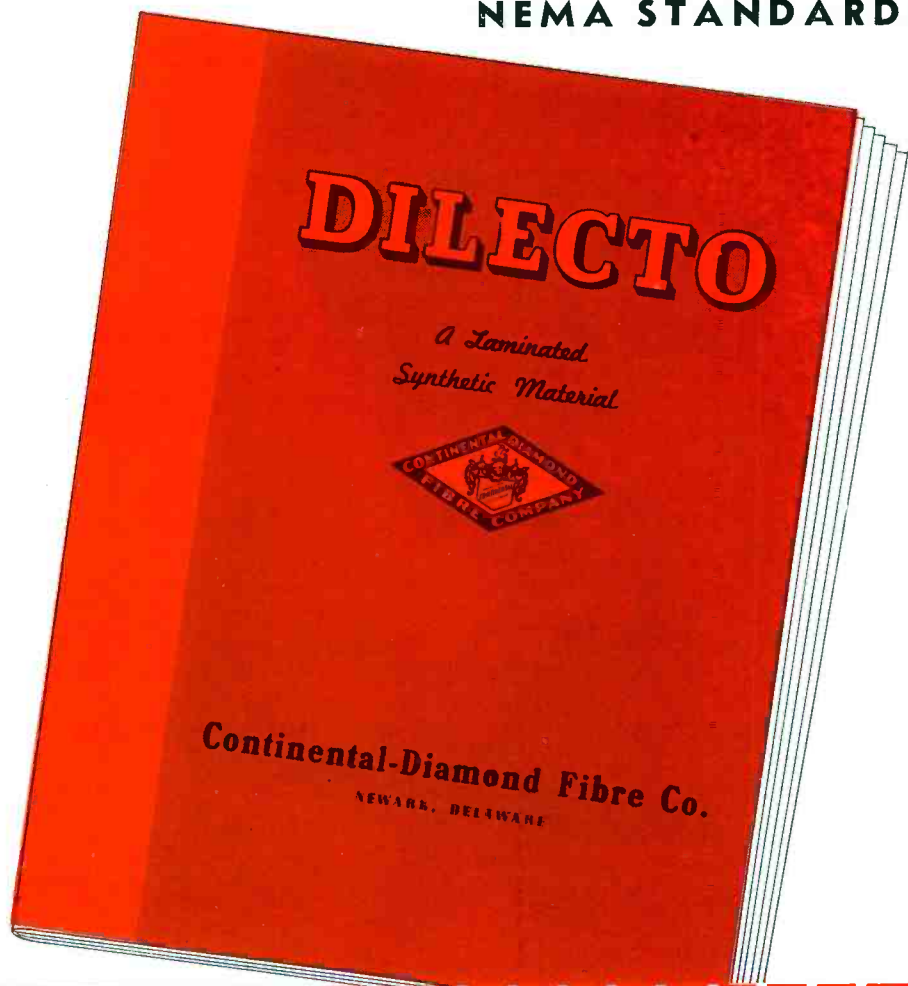

*Send this coupon  
today for your  
Copy*

**CONTINENTAL-DIAMOND FIBRE CO.**

Chapel St.

NEWARK, DELAWARE

NAME .....

COMPANY .....

ADDRESS .....

# Parade of Progress

## PROVES WORTH OF RCA POLICY!



"To provide you with the finest in transmitting tubes, at the lowest possible cost," is a creed with RCA. And these recent RCA accomplishments are the result!

### BROADCAST ECONOMY

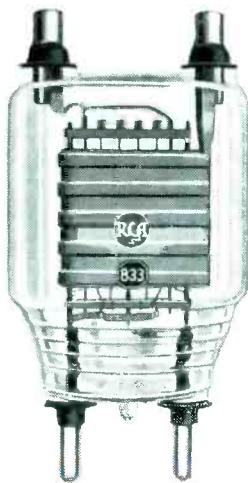

The RCA 833 combines high efficiency with economy. Two of these tubes, each rated at 500 watts by F. C. C. may be used as final r-f stage in 1 kw. transmitters.



Another RCA achievement in money-saving design is the air-cooled power tube available in two types — 891-R and 892-R. These tubes provide the design advantages of water-cooled tube construction, eliminate the expense water cooling incurs.

### HIGH POWER U.H.F. TRANSMISSION

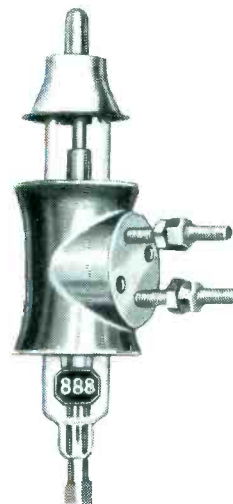

In the field of water-cooled tubes RCA offers the 887 and 888 which make possible the opening with adequate power of the enormous territory between 3 and 1 1/4 meters. These tubes are rated at 1200 watts max. input for wave lengths down to 1 1/4 meters. Power input and output capability for 1 1/4 meters is many times that of any other tube available.

### LINE OF SIGHT TRANSMISSION

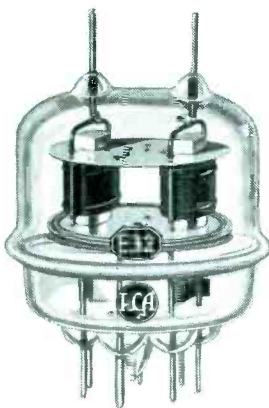

The RCA 832 gives exceptional performance at frequencies from 100 to 300 MC. Is designed primarily for use as a push-pull U.H.F. power amplifier with maximum ratings at wave lengths as short as two meters. With reduced ratings it may be operated at wave lengths down to one meter. Excellent for use in transmitters intended for line of sight communication.

### TELEVISION AMPLIFIERS



With interest in television mounting steadily, RCA engineers designed the 1852 and 1853 primarily for use in the picture channel amplifier circuit of television receivers. While these are not transmitting tubes they are an important RCA contribution to the industry and as such, belong in this parade of progress.

### ULTRA-HIGH FREQUENCY APPLICATION

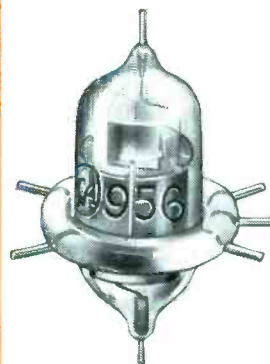

RCA's sensational acorn family, used chiefly by amateurs, is an outstanding advance in ultra-high frequency communication. Illustrated here is the RCA 956, a super-control r-f pentode which controls gain in r-f and permits a reduction in cross modulation. Other members of the acorn family are the RCA 954 and 955.

RCA presents the Magic Key. Sundays, 2 to 3 P. M., E. D. S. T., on the NBC Blue Network.

IT PAYS  
TO BUY...



# Radio Tubes

First in metal  
foremost in glass  
finest in performance

RCA MANUFACTURING CO., INC., CAMDEN, N. J. • A Service of the Radio Corporation of America